



# PLASTIC HOSE CLAMP PRODUCTS

*Technical Booklet*



S E P T E M B E R 2 0 1 6



## Technical Information

Below is the index for the complete HCL Plastic Hose Clamp Products Technical Booklet. Through many years experience in the manufacture of plastic hose clamps, HCL has built up extensive supplier relationships and knowledge of in-depth technical information. Should you require any information outside of the scope of this booklet, please contact HCL directly.



### Hose Clamp Products

- 1.1 Herbie Clip® Dimensions and Weights
- 1.2 Ezyklik™-P Dimensions and Weights
- 1.3 Special Clamp Designs

### Installation Tools

- 2.1 Manual Tools
- 2.2 Pneumatic Tools
- 2.3 Electro-Pneumatic Tools

### Performance

- 3.1 Pneumatic Tool Tightening Forces
- 3.2 Polar Diagrams
- 3.3 In-house Testing
- 3.4 3rd Party Testing

### Material

- 4.1 Definitions of Material Properties
- 4.2 Material Properties
- 4.3 Performance
- 4.4 Weathering
- 4.5 Chemical Resistance
- 4.6 Sterilisation

### Quality

- 5.1 Quality Procedure

## Herbie Clip® Dimensions & Weights

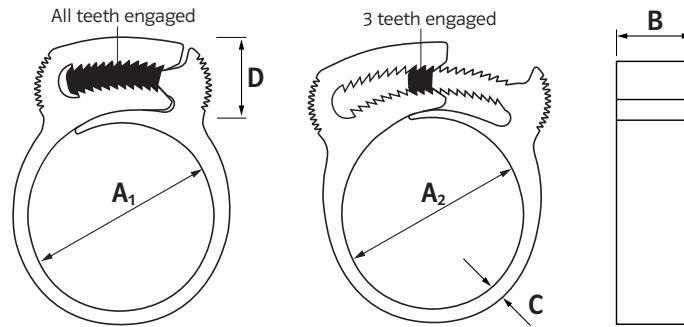

HCL Part No	Diameter Range (A <sub>1</sub> - A <sub>2</sub> )		Width (B)		Band Thickness (C)		Head Height (D)		Nylon 6.6 Weight		Polypropylene Weight	
	mm	inch	mm	inch	mm	inch	mm	inch	grams	ounces	grams	ounces
HC-A	5.6 - 6.5	0.220 - 0.256	4.2	0.170	1.4	0.055	8.3	0.330	0.51	0.017	0.41	0.014
HC-AA	6.5 - 7.9	0.256 - 0.311	4.5	0.180	1.6	0.063	9.9	0.390	0.83	0.028	0.63	0.022
HC-B	7.9 - 9.2	0.311 - 0.362	4.6	0.180	1.6	0.063	9.3	0.370	0.83	0.028	0.65	0.022
HC-BB	9.2 - 10.3	0.362 - 0.406	4.5	0.180	1.7	0.067	10.9	0.430	1.03	0.035	0.8	0.027
HC-C	10.2 - 11.8	0.402 - 0.465	5.8	0.230	1.7	0.067	12.2	0.480	1.71	0.059	1.3	0.045
HC-CC	11.1 - 12.9	0.437 - 0.508	6.1	0.240	1.7	0.067	12.3	0.480	1.92	0.066	1.49	0.051
HC-D	12.0 - 13.8	0.472 - 0.543	6.1	0.240	1.7	0.067	12.9	0.510	1.77	0.061	1.37	0.047
HC-E	13.1 - 15.1	0.516 - 0.594	7.2	0.280	2.0	0.079	13.6	0.540	2.93	0.1	2.29	0.078
HC-F	15.0 - 17.1	0.591 - 0.673	7.1	0.280	2.0	0.079	12.9	0.510	3.07	0.105	2.41	0.083
HC-G	16.9 - 19.1	0.670 - 0.752	6.9	0.270	2.1	0.083	12.5	0.490	2.78	0.095	2.19	0.075
HC-H	18.1 - 20.6	0.713 - 0.811	7.1	0.280	2.1	0.083	12.7	0.500	3.16	0.108	2.45	0.084
HC-J	20.3 - 23.0	0.799 - 0.906	6.4	0.250	2.1	0.083	14.2	0.560	3.49	0.12	2.65	0.091
HC-K	22.2 - 24.9	0.874 - 0.980	7.0	0.280	2.0	0.079	13.0	0.510	3.58	0.123	2.76	0.095
HC-L	24.5 - 27.6	0.965 - 1.087	7.1	0.280	2.1	0.083	12.5	0.490	3.61	0.124	2.83	0.097
HC-M	26.5 - 29.5	1.043 - 1.161	7.4	0.290	2.2	0.087	13.4	0.530	4.93	0.169	3.81	0.131
HC-N	28.8 - 32.2	1.134 - 1.268	9.0	0.350	2.0	0.079	13.4	0.530	5.83	0.2	4.31	0.148
HC-P	32.0 - 34.8	1.260 - 1.370	9.1	0.360	2.2	0.087	13.8	0.540	5.83	0.2	4.57	0.157
HC-Q	34.3 - 37.9	1.350 - 1.492	8.9	0.350	2.1	0.083	13.5	0.530	6.24	0.214	4.83	0.166
HC-R	38.0 - 41.0	1.496 - 1.614	9.2	0.360	2.1	0.083	14.1	0.560	6.47	0.222	5.07	0.174
HC-S	40.1 - 44.2	1.580 - 1.740	9.0	0.350	2.2	0.087	13.4	0.530	6.47	0.222	5.05	0.173
HC-T	43.2 - 46.2	1.701 - 1.819	8.9	0.350	2.1	0.083	12.8	0.500	6.54	0.224	5.22	0.179
HC-U	46.0 - 50.5	1.811 - 1.988	9.0	0.350	2.1	0.083	14.4	0.570	7.01	0.24	5.34	0.183
HC-V	48.5 - 53.8	1.909 - 2.118	9.0	0.350	2.1	0.083	14.4	0.570	7.95	0.272	6.03	0.207
HC-W	53.0 - 56.5	2.087 - 2.224	9.0	0.350	2.1	0.083	15.0	0.590	8.12	0.278	6.22	0.213
HC-X	55.0 - 60.5	2.165 - 2.382	9.4	0.370	2.3	0.091	15.5	0.610	9.83	0.337	7.63	0.261
HC-59	59.0 - 64.7	2.323 - 2.547	9.3	0.370	2.7	0.106	17.0	0.670	10.17	0.349	7.93	0.27
HC-64	63.0 - 67.4	2.480 - 2.654	9.4	0.370	2.6	0.102	15.6	0.610	9.47	0.325	7.39	0.253
HC-66	65.8 - 71.7	2.591 - 2.823	9.2	0.360	1.95	0.076	15.7	0.620	10.9	0.374	8.5	0.291
HC-70	70.0 - 75.4	2.756 - 2.969	9.1	0.360	2.6	0.102	15.5	0.610	11.8	0.404	9.2	0.315
HC-75	74.7 - 80.5	2.941 - 3.169	9.1	0.360	2.6	0.102	16.5	0.650	13.04	0.447	10.17	0.349
HC-80	79.8 - 85.0	3.142 - 3.346	9.0	0.350	2.9	0.114	17.7	0.700	12.27	0.42	9.57	0.328
HC-85	85.1 - 90.6	3.350 - 3.567	8.9	0.350	2.6	0.102	17.2	0.680	11.96	0.41	9.33	0.32
HC-91	91.0 - 96.0	3.583 - 3.780	9.5	0.370	2.6	0.102	16.7	0.660	11.5	0.394	8.97	0.307
HC-96	97.7 - 102.1	3.846 - 4.020	8.5	0.340	2.6	0.102	17.4	0.690	13.84	0.474	10.8	0.37
HC-105	105.3 - 111.8	4.146 - 4.402	8.9	0.350	2.6	0.102	16.2	0.640	14.41	0.494	11.24	0.385
HC-109	108.0 - 114.3	4.252 - 4.500	9.0	0.350	2.6	0.102	17.4	0.690	15.55	0.533	12.13	0.416
HC-115	115.0 - 121.0	4.528 - 4.763	9.5	0.370	2.6	0.102	17.4	0.690	14.9	0.511	11.62	0.398
HC-163	163.0 - 169.0	6.417 - 6.654	9.5	0.370	2.5	0.098	16.0	0.630	18.82	0.645	14.68	0.503

ALL WEIGHTS AND DIMENSIONS ARE ±2.5%

## Ezyklik™-P Dimensions & Weights

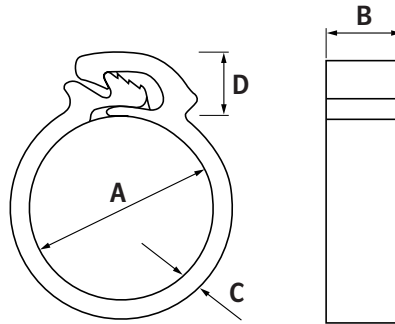

HCL Part No	Closed Diameter (A)		Width (B)		Band Thickness (C)		Head Height (D)		Nylon 6.6 Weight		Nylon 6.6 GF Weight		Polypropylene Weight	
	mm	inch	mm	inch	mm	inch	mm	inch	grams	ounces	grams	ounces	grams	ounces
EZY-P-8.5	8.5	0.335	8.0	0.315	1.7	0.067	5.3	0.21	0.77	0.027	0.92	0.032	0.61	0.022
EZY-P-8.7	8.7	0.343	8.0	0.315	1.7	0.067	5.3	0.21	0.76	0.027	0.91	0.032	0.61	0.021
EZY-P-8.9	8.9	0.350	8.0	0.315	1.7	0.067	5.3	0.21	0.77	0.027	0.93	0.033	0.61	0.022
EZY-P-9.2	9.2	0.362	8.0	0.315	1.7	0.067	5.3	0.21	0.77	0.027	0.93	0.033	0.61	0.022
EZY-P-9.5	9.5	0.374	8.0	0.315	1.7	0.067	5.3	0.21	0.82	0.029	0.99	0.035	0.66	0.023
EZY-P-10.0	10.0	0.394	8.0	0.315	1.7	0.067	5.3	0.21	0.82	0.029	0.99	0.035	0.66	0.023
EZY-P-11.4	11.4	0.449	8.0	0.315	1.7	0.067	5.5	0.22	0.93	0.033	1.12	0.040	0.75	0.026
EZY-P-12.0	12.0	0.472	8.0	0.315	1.7	0.067	5.6	0.22	0.97	0.034	1.16	0.041	0.77	0.027
EZY-P-12.5	12.5	0.492	8.0	0.315	1.7	0.067	5.7	0.22	0.99	0.035	1.19	0.042	0.79	0.028
EZY-P-12.7	12.7	0.500	8.0	0.315	1.7	0.067	5.8	0.23	0.99	0.035	1.19	0.042	0.79	0.028
EZY-P-13.2	13.2	0.520	8.0	0.315	1.7	0.067	5.8	0.23	1.01	0.036	1.21	0.043	0.81	0.028
EZY-P-13.7	13.7	0.539	8.0	0.315	1.7	0.067	5.8	0.23	1.03	0.036	1.24	0.044	0.82	0.029
EZY-P-14.5	14.5	0.571	8.0	0.315	2.0	0.079	6.8	0.27	1.39	0.049	1.68	0.059	1.11	0.039
EZY-P-14.6	14.6	0.575	8.0	0.315	2.0	0.079	6.8	0.27	1.39	0.049	1.67	0.059	1.11	0.039
EZY-P-15.0	15.0	0.591	8.0	0.315	2.0	0.079	6.8	0.27	1.41	0.050	1.70	0.060	1.13	0.040
EZY-P-15.7	15.7	0.618	8.0	0.315	2.0	0.079	6.8	0.27	1.44	0.051	1.73	0.061	1.15	0.041
EZY-P-15.9	15.9	0.626	8.0	0.315	2.0	0.079	6.8	0.27	1.45	0.051	1.75	0.062	1.16	0.041
EZY-P-16.5	16.5	0.650	8.0	0.315	2.0	0.079	6.8	0.27	1.48	0.052	1.78	0.063	1.18	0.042
EZY-P-16.8	16.8	0.661	8.0	0.315	2.0	0.079	6.8	0.27	1.58	0.056	1.89	0.067	1.26	0.044
EZY-P-17.1	17.1	0.673	8.0	0.315	2.0	0.079	6.8	0.27	1.51	0.053	1.81	0.064	1.20	0.042
EZY-P-17.5	17.5	0.689	8.0	0.315	2.0	0.079	6.8	0.27	1.53	0.054	1.84	0.065	1.22	0.043
EZY-P-17.6	17.6	0.693	8.0	0.315	2.0	0.079	6.8	0.27	1.49	0.053	1.79	0.063	1.19	0.042
EZY-P-18.0	18.0	0.709	8.0	0.315	2.0	0.079	6.8	0.27	1.53	0.054	1.84	0.065	1.22	0.043
EZY-P-18.5	18.5	0.728	8.0	0.315	2.0	0.079	6.8	0.27	1.57	0.055	1.89	0.067	1.25	0.044
EZY-P-19.1	19.1	0.752	8.0	0.315	2.0	0.079	6.8	0.27	1.58	0.056	1.90	0.067	1.26	0.044
EZY-P-19.6	19.6	0.772	8.0	0.315	2.0	0.079	6.8	0.27	1.61	0.057	1.93	0.068	1.29	0.045
EZY-P-20.1	20.1	0.791	8.0	0.315	2.0	0.079	6.8	0.27	1.62	0.057	1.95	0.069	1.29	0.046
EZY-P-20.8	20.8	0.819	8.0	0.315	2.0	0.079	6.8	0.27	1.74	0.061	2.10	0.074	1.39	0.049
EZY-P-21.1	21.1	0.831	8.0	0.315	2.0	0.079	6.8	0.27	1.67	0.059	2.01	0.071	1.33	0.047
EZY-P-22.0	22.0	0.866	8.0	0.315	2.0	0.079	6.8	0.27	1.82	0.064	2.19	0.077	1.45	0.051
EZY-P-22.1	22.1	0.870	8.0	0.315	2.0	0.079	6.8	0.27	1.73	0.061	2.08	0.073	1.38	0.049
EZY-P-22.6	22.6	0.890	8.0	0.315	2.0	0.079	6.8	0.27	1.75	0.062	2.10	0.074	1.40	0.049
EZY-P-23.1	23.1	0.909	8.0	0.315	2.0	0.079	6.8	0.27	1.77	0.062	2.13	0.075	1.42	0.050
EZY-P-23.6	23.6	0.929	8.0	0.315	2.0	0.079	6.8	0.27	1.82	0.064	2.19	0.077	1.45	0.051
EZY-P-24.7	24.7	0.972	8.0	0.315	2.0	0.079	6.8	0.27	1.96	0.069	2.36	0.083	1.57	0.055
EZY-P-25.8	25.8	1.016	8.0	0.315	2.0	0.079	6.8	0.27	2.02	0.071	2.43	0.086	1.62	0.057
EZY-P-26.8	26.8	1.055	8.0	0.315	2.0	0.079	6.8	0.27	2.08	0.073	2.50	0.088	1.66	0.059
EZY-P-28.0	28.0	1.102	8.0	0.315	2.0	0.079	6.8	0.27	2.12	0.075	2.55	0.090	1.70	0.060
EZY-P-30.6	30.6	1.205	9.0	0.354	2.0	0.079	6.8	0.27	2.69	0.095	3.23	0.114	2.15	0.076
EZY-P-31.4	31.4	1.236	9.0	0.354	2.0	0.079	6.8	0.27	2.63	0.093	3.16	0.111	2.10	0.074
EZY-P-36.5	36.5	1.437	9.0	0.354	2.5	0.098	6.8	0.27	3.57	0.126	4.30	0.152	2.85	0.101
EZY-P-42.4	42.4	1.669	9.0	0.354	2.5	0.098	7.3	0.29	4.15	0.146	4.99	0.176	3.31	0.117
EZY-P-43.3	43.3	1.705	9.0	0.354	2.5	0.098	7.3	0.29	4.21	0.149	5.06	0.178	3.36	0.119
EZY-P-45.5	45.5	1.791	9.0	0.354	2.5	0.098	7.3	0.29	4.37	0.154	5.25	0.185	3.49	0.123

ALL WEIGHTS AND DIMENSIONS ARE ±2.5%



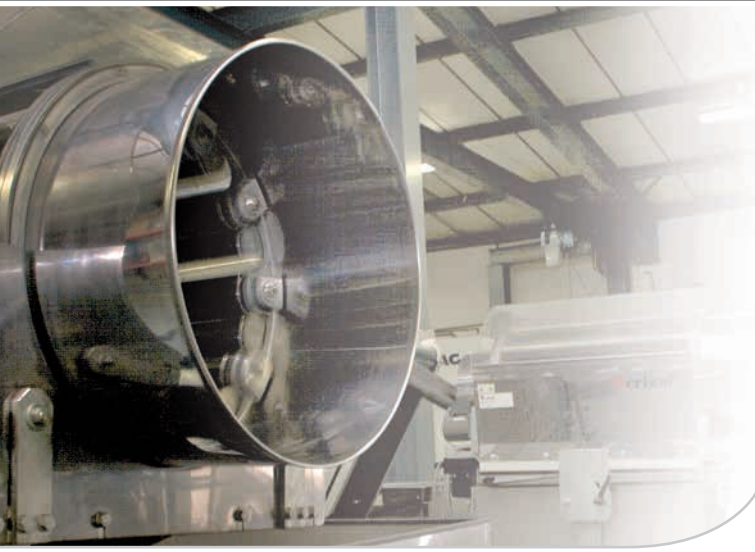

## Special Clamp Designs

From time to time, customers approach HCL with applications requiring a bespoke clamp design. On such occasions, HCL's in-house product development team will work closely with the customer to produce a unique clamp, based on either the Herbie Clip® or the Ezyklik™-P, but designed specifically for the particular application.

Below are a few examples of special clamp designs:



**Herbie Clip® Capacitor Cradle**

This special clamp is based on the Herbie Clip® and has been adapted to function as a capacitor cradle. The clamp incorporates a rectangular recess for fixing it to a sheet metal frame and a living hinge for isolating the capacitor from the frame.



**Ezyklik™ Fuel Pump Spigot Retaining Clamp**

This bespoke clamp is based on the Ezyklik™-P and has been modified to retain a moulded spigot in a cast automotive fuel pump housing. The clamp profile was designed to fit snugly around the housing boss, with various retaining features to prevent removal of the spigot or the clamp.



**Herbie Clip® Dishwasher Clamp**

This special Herbie Clip® is narrower than a standard clip, in order for it to fit in the restricted space of a certain dishwasher application. The head of the clip is full width where possible, so that the clip can be satisfactorily tightened using the Herbie Clip® Hand Tool.



**Herbie Clip® Washing Machine Door Seal Clamp**

This special clamp is based on the Herbie Clip® and has been adapted to retain the rubber door seal on a washing machine. The clamp incorporates various bespoke features, including sealing, retaining and strengthening ribs.

## Manual Tools



**Herbie Clip® - Vertical Tool**

PART NUMBER	<b>MT-HC-VFT-01</b>
DIMENSIONS	<b>225x125x25mm</b>
WEIGHT	<b>0.46kg</b>
BOX QUANTITY	<b>1</b>

APPLICABLE CLAMPS

**Herbie Clip® Sizes A-85**

This ergonomic tool incorporates adjustable stops that can be set up for a given size of Herbie Clip® in order to achieve consistent tightening.



**Adjustable Waterpump Pliers**

PART NUMBER	<b>MT-PL-01</b>
DIMENSIONS	<b>235x205x20mm</b>
WEIGHT	<b>0.34kg</b>
BOX QUANTITY	<b>1</b>

APPLICABLE CLAMPS

**Herbie Clip®**

These versatile pliers can be used to tighten the entire Herbie Clip® range.



**Herbie Clip® - Removal Tool**

PART NUMBER	<b>MT-HC-RT-01</b>
DIMENSIONS	<b>160x50x3mm</b>
WEIGHT	<b>0.09kg</b>
BOX QUANTITY	<b>1</b>

APPLICABLE CLAMPS

**Herbie Clip®**

This lightweight tool is designed for the removal of all sizes of the Herbie Clip® range.



**Ezyklik™-P - Lightweight Vertical Tool**

PART NUMBER	<b>MT-EZP-LVT-01</b>
DIMENSIONS	<b>180x125x30mm</b>
WEIGHT	<b>0.10kg</b>
BOX QUANTITY	<b>1</b>

APPLICABLE CLAMPS

**Ezyklik™-P**

This lightweight, ergonomic tool is designed to tighten all sizes of the Ezyklik™-P range.



**Ezyklik™-P - Horizontal Tool**

PART NUMBER	<b>MT-EZP-HT-01</b>
DIMENSIONS	<b>230x135x25mm</b>
WEIGHT	<b>0.37kg</b>
BOX QUANTITY	<b>1</b>

APPLICABLE CLAMPS

**Ezyklik™-P**

This ergonomic tool is designed to tighten all sizes of the Ezyklik™-P range.

## Pneumatic Tools



**Herbie Clip® – Calliper Tool**  
(Various Jaw options available)

**Handle Options:**

- Gun grip (shown)
- Straight grip
- Vertical grip

PART NUMBER	<b>PT-HC-C</b>
DIMENSIONS	<b>240x80x170mm</b>
WEIGHT	<b>0.89kg</b>
BOX QUANTITY	<b>1</b>
APPLICABLE CLAMPS	
<b>Herbie Clip® Sizes F-85</b>	



**Herbie Clip® – Piston Tool**  
(Various Piston options available)

**Handle Options:**

- Gun grip
- Straight grip (shown)
- Vertical grip

PART NUMBER	<b>PT-HC-P</b>
DIMENSIONS	<b>335x55x65mm</b>
WEIGHT	<b>0.66kg</b>
BOX QUANTITY	<b>1</b>
APPLICABLE CLAMPS	
<b>Herbie Clip® Sizes A-105</b>	



**Ezyklik™ – Calliper Tool**  
(Various Jaw options available)

**Handle Options:**

- Gun grip
- Straight grip
- Vertical grip (shown)

PART NUMBER	<b>PT-EZY-C</b>
DIMENSIONS	<b>60x60x270mm</b>
WEIGHT	<b>0.91kg</b>
BOX QUANTITY	<b>1</b>
APPLICABLE CLAMPS	
<b>Ezyklik™-P</b>	

### Pneumatic Tool Handle Options

There are three pneumatic tool handle options, which are detailed below:



**Gun Grip**

This handle option is suitable for both vertical and horizontal access to the hose clamp. It can be used with a counterbalance and air input can be either vertical or horizontal.



**Straight Grip**

This handle option is ideal for applications with horizontal access to the hose clamp. It can be used with a counterbalance and air input can be either vertical or horizontal.



**Vertical Grip**

This handle option is ideal for applications with vertical access to the hose clamp. It is particularly suited for use with a counterbalance and vertical air input.



## Electro-Pneumatic Tools

Developed exclusively for the range of Herbie Clip® pneumatic tools, the Pneumatic Control time delay system offers a higher level of air pressure control.



Control Box (works with Piston and Calliper tools)

PART NUMBER	<b>PT-CB-01</b>
DIMENSIONS	<b>300x320x145mm</b>
WEIGHT	<b>3.90kg</b>
BOX QUANTITY	<b>1</b>

In the drive to eliminate error from production lines the control system has two main features:

### Time Delay

Maintains consistent tightening time

### Pressure Control

Maintains consistent tightening force

Other features include:

#### Speed Control

Prevents the tool tightening too rapidly but releases quickly.

#### Dual Inputs

Tool can be operated using the tool trigger or an auxiliary device, such as a foot switch.

#### High Pressure

Designed for use up to 10 bar (145psi)

#### Air Regulation

Accurate control of tightening force

#### External Signal Output

A voltage output can be supplied to the production line if so desired to record tightening results.

The tool can be tailored to suit individual customers needs and can be supplied with any combination of the main features.

The unit is virtually maintenance free and HCL provides full backup and servicing support.



## Pneumatic Tool Tightening Forces

The graph below shows the tightening forces produced by each of the Herbie Clip® pneumatic tools at a given input pressure:

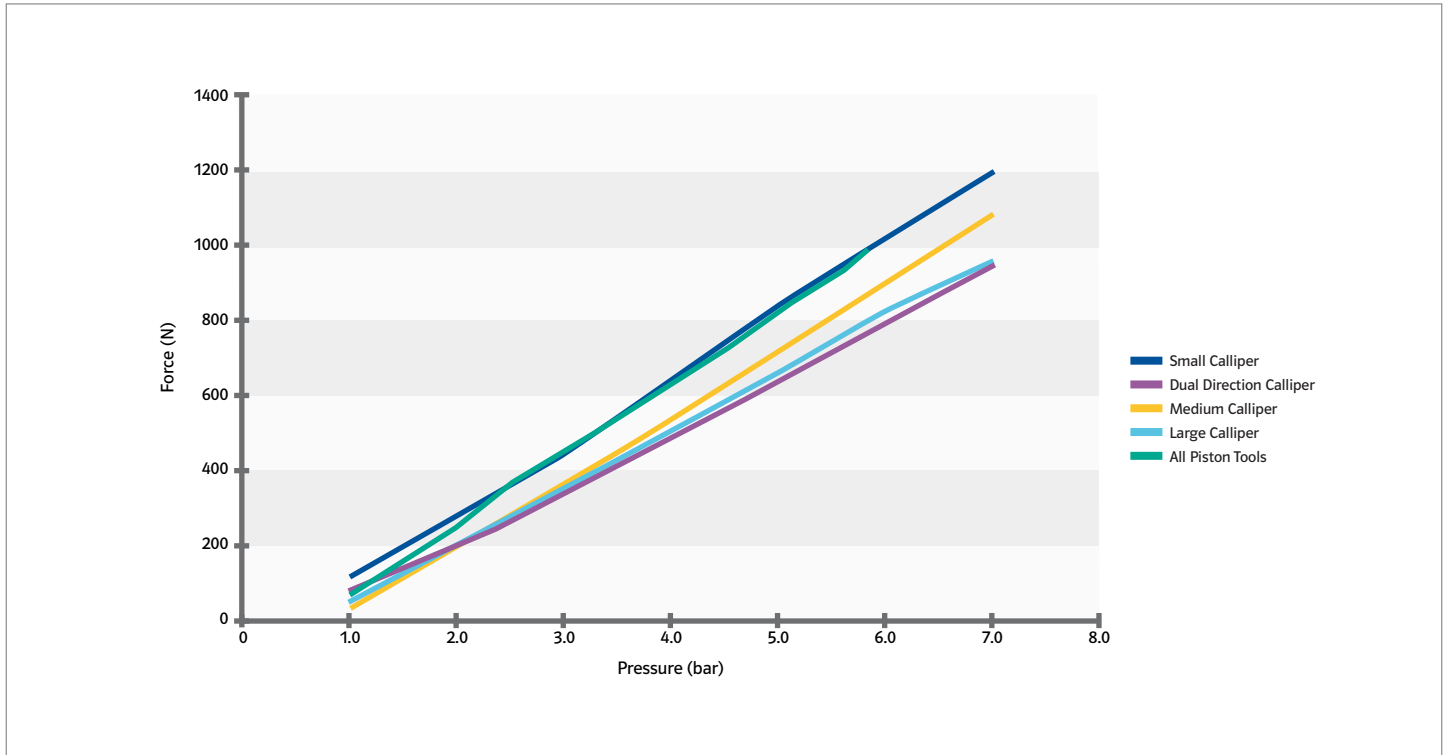

## Polar Diagrams

The chart below shows the results of a test carried out with strain gauges at eight points on a 38 mm diameter (nominal) rubber hose, using a Nylon 6.6. size Q Herbie Clip® with all eight teeth engaged. The forces are relatively uniform around the hose with a modest 20% increase underneath the Herbie Clip® head.

Position Number	Position °	Force N
1	0	157
2	45	128
3	90	128
4	135	120
5	180	120
6	225	112
7	270	115
8	315	119

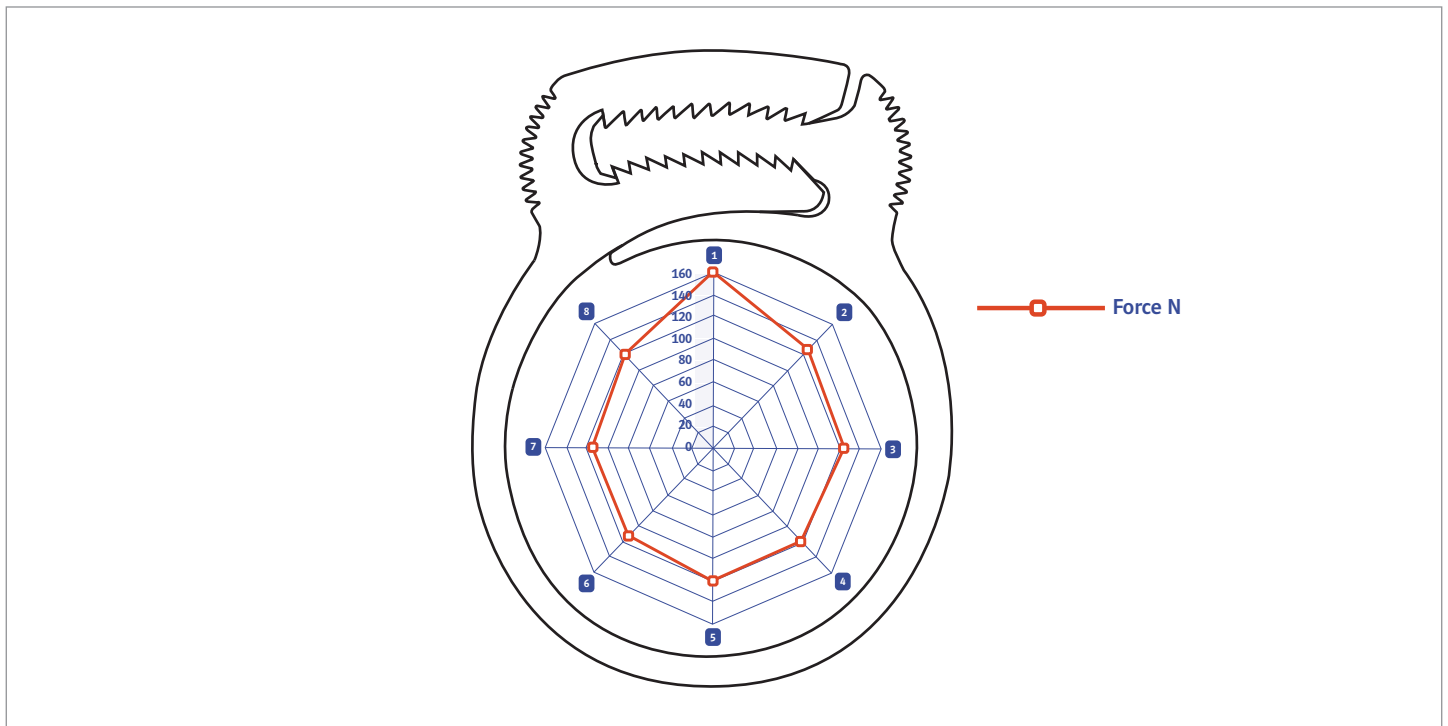

## In-house Testing

Over many years, HCL has carried out comprehensive in-house testing of its range of plastic hose clamps. As the sealing capability of each application is dependent, not only on the hose clamp, but also on the hose and pipe fitting; much of the testing has involved validating the performance of the hose clamps for a particular customer application. One such example of in-house pressure testing is detailed below.

### Method – Pressure testing

Pressure sealing performance was measured using a hand pump capable of delivering 50bar (725psi) and a pressure medium of water at 40°C (104°F). The PVC braided reinforced hose and barbed pipe fitting shown below were tested with size F Herbie Clips® and size 15.0 Ezyklik™-P clamps, in both **PA66 (Nylon 6.6.)** and **PP (Polypropylene)**. The tests were carried out three times per clamp.



### Results

Hose Clamp	Size	Material	Failure Pressure (Bar)				
			1	2	3	Lowest	Average
Herbie Clip®	F	PA66	33.0	32.0	31.0	31.0	32.0
Ezyklik™-P	15.0	PA66	30.0	26.0	29.0	26.0	28.3
Herbie Clip®	F	PP	26.0	24.0	24.5	24.0	24.8
Ezyklik™-P	15.0	PP	19.0	18.5	19.0	18.5	18.8
No clamp			2.0	1.0	1.5	1.0	1.5

### Conclusions

- For the above PVC braided reinforced hose and barbed pipe fitting, the Herbie Clip® size F is capable of sealing up to 31bar (450psi) and the Ezyklik™-P size 15.0 capable of sealing up to 26.0bar (375psi). It should be noted that this could be higher or lower for other applications, depending on the hose and pipe fitting. The pressure sealing capability of the Herbie Clip® and Ezyklik™-P would be expected to be lower for unreinforced hose, or a non-barbed pipe fitting.
- The Herbie Clip® is stronger than the equivalent Ezyklik™-P hose clamp.
- **PA66 (Nylon 6.6.)** is a stronger material than **PP (Polypropylene)**.

## 3rd Party Testing

As well as In-house testing, numerous tests and approvals of HCL's plastic hose clamps have been carried out by leading companies and organisations throughout the world. One such example of 3rd party testing, by the Mechanical Engineering Department of Manchester Metropolitan University, is detailed below. The scope of the investigation was to establish the pressure sealing characteristics and effectiveness of the Herbie Clip® double toothed jaw. A comparison was also carried out with competitor's single toothed jaw hose clamps.

### Method 1 – Air Pressurisation

Pressure sealing performance was measured using an air pressurisation arrangement with a pump capable of delivering 17bar (250psi) as shown below. The tests were carried out with Nylon 6.6. size N Herbie Clips® clamped to 1" bore soft rubber hose and braided PVC hose, using a 700N circumferential tightening force.

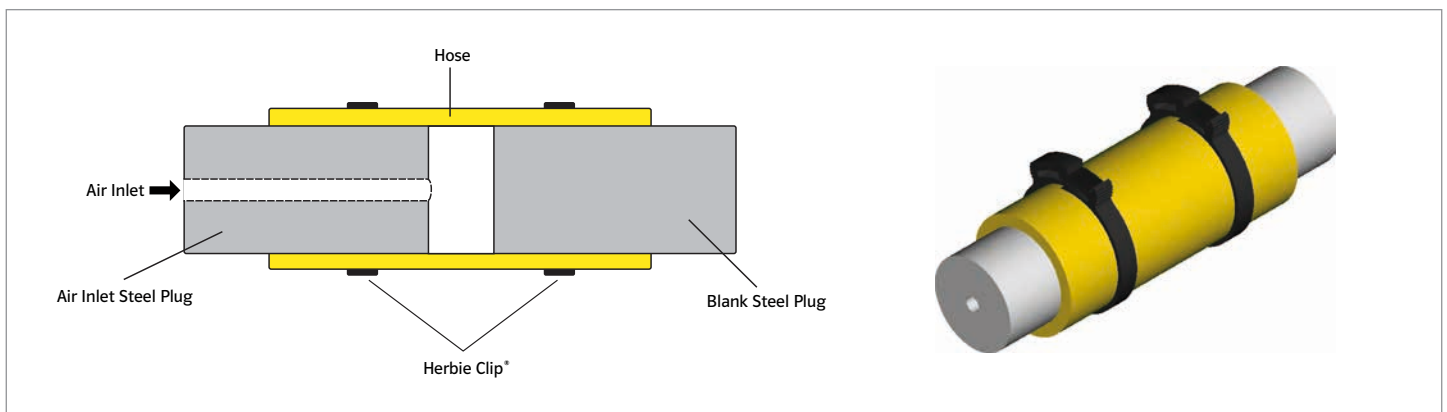

### Method 2 – Circumferential Loading

A special purpose test rig was constructed to permit tests of the absolute strength of the Herbie Clip® double toothed jaw and band. The test rig facilitated circumferential loading of the toothed jaw in a manner representative of a clamp fitted to an internally pressurised hose, as shown below.

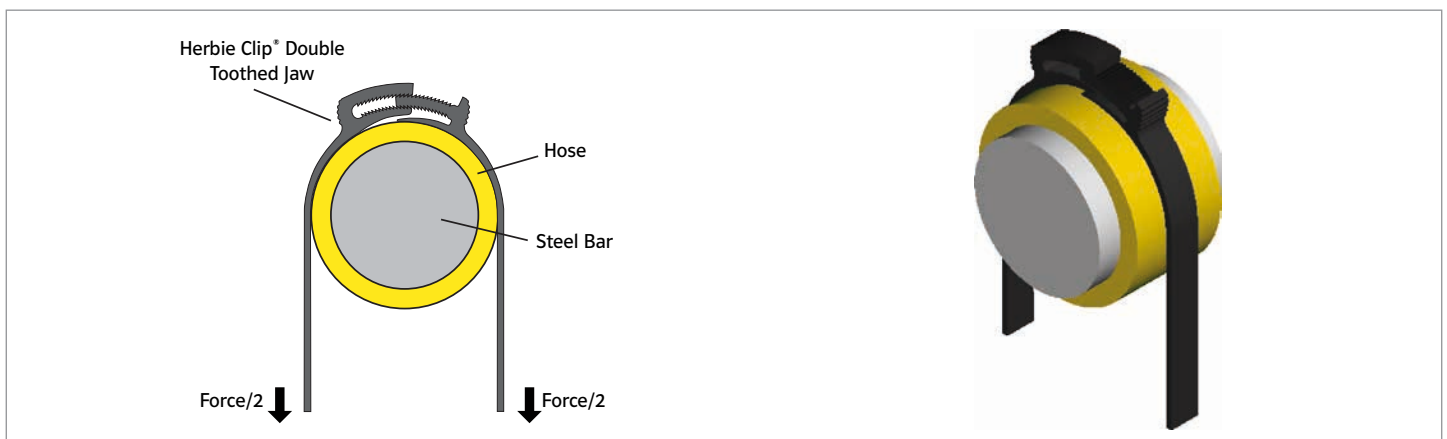

### Results & Conclusions

- The leakage pressure for the Herbie Clip® in the above test arrangement, was 5.5bar (80psi) for the braided PVC hose and 12.5bar (180psi) for the soft rubber hose. These figures were increased to 12.5bar (180psi) and 14bar (200psi) respectively, when the bore of the Herbie Clip® was greased before application.
- In all cases, the Herbie Clip® leakage pressure was better than or equal to the equivalent competitor single toothed jaw hose clamps. In most cases, the Herbie Clip® leakage pressure was 2-3 times higher than for competitor clamps.
- The circumferential loading tests concluded that the Herbie Clip® only required two teeth to be engaged for satisfactory performance (HCL recommends a minimum of three teeth are engaged). With two teeth engaged, the Herbie Clip® failed in tension under a total circumferential force of 1000N.



## Definitions of Material Properties

Physical Properties	
<b>Density</b>	Mass per Volume, also known as 'Specific Gravity'. The units $g/cm^3 = g/ml$
<b>Water Absorption at 23°C</b>	The mass of water absorbed from the atmosphere as a % of the total mass. Two measurements are made in 50% relative humidity: one 24 hours after moulding and the other when an equilibrium (constant quantity) is reached.
<b>UL94 Flammability Class (0.75 - 3.0mm Thickness)</b>	V-2 rating: Burning stops within 60 seconds, after two applications of ten seconds each, of a flame to a test bar. Flaming drips ARE allowed. H-B rating: Slow horizontal burning on a specimen, where the burning rate is less than 3"/min, or stops burning before the 5" mark. H-B rated materials are considered "self-extinguishing". This is the lowest (least flame retardant) UL94 rating.
Mechanical Properties	
<b>Tensile:</b>	Material properties exhibited whilst under tension. A test specimen is held at both ends and loaded so that the specimen is stretched under tension.
<b>Modulus</b>	A measure of the stiffness of a material during elastic (non-permanent) deformation. Tensile Modulus = Tensile Stress / Tensile Strain = (Force / Area) / (Increase in Length / Original Length)
<b>Strength at Yield</b>	The Stress (Force per Area) required to yield a test bar, i.e. to cause plastic (permanent) deformation.
<b>Strength at Break</b>	The Stress (Force per Area) required to break a test bar.
<b>Elongation at Yield</b>	The % increase in length of a test bar at the Yield point, i.e. at the onset of plastic (permanent) deformation. Elongation = Strain x 100
<b>Elongation at Break</b>	The % increase in length of a test bar at the break point, i.e. when the material fractures. Elongation = Strain x 100
<b>Flexural:</b>	Material properties exhibited whilst under flexure (bending). A test specimen is supported at both ends and a load applied at the mid-point of the specimen in order to cause 3-point bending.
<b>Modulus</b>	A measure of the stiffness of a material during elastic (non-permanent) deformation. Flexural Modulus = Flexural Stress / Flexural Strain = $\{(3 \times \text{Force} \times \text{Length}) / (2 \times \text{Width} \times \text{Height}^2)\} / \{(6 \times \text{Deflection} \times \text{Height}) / (\text{Length}^2)\}$ = $(\text{Force} \times \text{Length}^3) / (4 \times \text{Width} \times \text{Height}^3 \times \text{Deflection})$
<b>Strength</b>	Also known as 'Modulus of Rupture' or 'Bend Strength'. The Stress required to break a test bar through 3-point bending.
<b>Impact Resistance:</b>	The relative susceptibility to fracture under stresses applied at high speeds.
<b>Izod notched at 23°C (73°F)</b>	The energy required to fracture a notched sample held in a cantilevered beam configuration.
<b>Charpy notched at 23°C (73°F)</b>	The energy required to fracture a notched sample held in a 3-point bending configuration.
Thermal Properties	
<b>Melting Point</b>	The temperature at which the Polymer melts, i.e. turns from a solid to a liquid.
<b>Heat Deflection Temperature</b>	A measure of short-term heat resistance. A test specimen is loaded in a 3-point bending configuration, then heated until a specified deflection is reached.
<b>Vicat Softening Temperature at 50N</b>	The temperature at which a flat-ended needle penetrates a test specimen to a depth of 1mm under a specified load.
<b>Coefficient of Linear Thermal Expansion</b>	A measure of the change in size of an object as its temperature changes.
Electrical Properties	
<b>Dielectric Strength (step-by-step) 3.0mm</b>	The voltage required to produce dielectric breakdown of the material, i.e. the maximum voltage the material can insulate per unit thickness.
<b>Volume Resistivity 3.0mm</b>	A measure of how strongly a material opposes the flow of electric current.
<b>Comparative Tracking Index 3.0mm</b>	The voltage which causes tracking after 50 drops of 0.1% ammonium chloride solution have fallen on the material. The results of testing at 3 mm thickness are considered representative of the material's performance in any thickness. Tracking is an electrical breakdown on the surface of an insulating material. A large voltage difference gradually creates a conductive leakage path across the surface of the material by forming a carbonized track.

## Material Properties

HCL's plastic hose clamps are primarily manufactured from black heat stabilised **PA66 (Nylon 6.6.)**, whilst **PA66 GF30 (Nylon 6.6. 30% Glass-filled)** or **PP (Polypropylene)** are available on request.

**PA66 (Nylon 6.6.)** provides high strength and good heat resistance, whereas **PP (Polypropylene)** gives improved resistance to chemicals such as strong acids or alkalis. **PA66 GF30 (Nylon 6.6. 30% Glass-filled)** provides higher strength and heat resistance than **PA66 (Nylon 6.6.)**, but lower electrical and flammability resistance.

	ISO Standard	Units	PA66 (Nylon 6.6.)		PA66 GF30 (Nylon 6.6. 30% Glass-filled)		PP (Polypropylene)	
			Dry As Moulded	Conditioned (50% RH)	Dry As Moulded	Conditioned (50% RH)	Herbie Clip*	Ezyklik™-P
<b>Physical Properties</b>								
Density	1183	g/cm <sup>3</sup>	1.14	1.14	1.37		0.90	0.90
<b>Water Absorption at 23°C</b>								
24 hours	62	%	1.1		0.9			
Equilibrium at 50% RH	62	%	2.4		1.9			
UL94 Flammability Class (0.75 - 3.0mm Thickness)	UL Flame Test		V-2	V-2	H-B	H-B		
<b>Mechanical Properties</b>								
<b>Tensile:</b>								
Modulus	527	Mpa	3000	1400	9400	7400		
Strength at Yield	527	Mpa	83	66			26	42
Strength at Break	527	Mpa			195	140	27	23
Elongation at Yield	527	%	4.5	25				
Elongation at Break	527	%	25	105	3		600	500
<b>Flexural:</b>								
Modulus	178	Mpa	2900	1350	9100	6000	1350	2100
Strength	178	Mpa	86	22	270	190		
<b>Impact Resistance:</b>								
Izod notched at 23°C (73°F)	180	kJ/m <sup>2</sup>	5.5		11		10	2.5
Charpy notched at 23°C (73°F)	179	kJ/m <sup>2</sup>	6.6		11.2		7.5	2.1
<b>Thermal Properties</b>								
Melting Point	3146	°C	260		260			
<b>Heat Deflection Temperature</b>								
1.82 Mpa	75	°C	70		250		52	59
0.45 Mpa	75	°C	200		260		83	119
Vicat Softening Temperature at 50N	306	°C	236		252		71	95
<b>Coefficient of Linear Thermal Expansion</b>								
2mm - Parallel, 23°C - 55°C		(10 <sup>-5</sup> mm/mm/°C)	1.1		0.25			
2mm - Normal, 23°C - 55°C		(10 <sup>-5</sup> mm/mm/°C)	1.2		1			
<b>Electrical Properties</b>								
Dielectric Strength (step-by-step) 3.0mm	IE 60243	kV/mm	20		16			
Volume Resistivity 3.0mm	IE 60093	ohm-cm x10 <sup>15</sup>	4		3			
Comparative Tracking Index 3.0mm	IE 60112	V	400-599		250-400			

## General Guidelines

### PA66 (Nylon 6.6.)

- Max. long term temp 125°C (255°F)
- Occasional Peak temp 170°C (340°F)
- Electrical applications requiring 600V or less and frequencies of 400Hz or lower

### PA66 GF30 (Nylon 6.6. 30% Glass-filled)

- Max. long term temperature 150°C (300°F)

### PP (Polypropylene)

- Max. long term temp 60°C (140°F)
- Occasional Peak temp 90°C (195°F)

### Performance and Reliability For Nylon 6.6.

Hose clamps manufactured from heat and UV stabilised Nylon 6.6. give very good strength properties and high temperature characteristics.

#### Strength at High Temperatures

The graph to the right shows the effect of air oven ageing of heat stabilised **PA66 (Nylon 6.6.)** on tensile strength. Note that at 132°C (270°F), there is no significant degradation of tensile strength, even after 4000 hours (approx. 170 days).

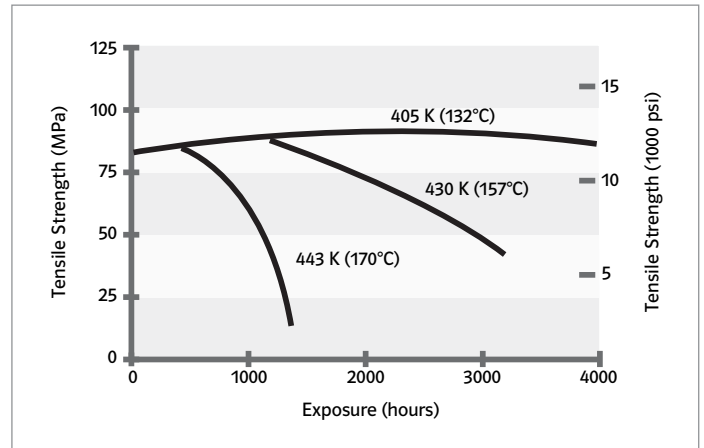

#### Creep and Relaxation

As is common to all plastics, **PA66 (Nylon 6.6.)** is susceptible to creep. This is the tendency of the material to deform under load, and in clamping applications this could lead to slackening of the clamp.

The graph to the right shows creep in flexure of heat stabilised **PA66 (Nylon 6.6.)** at 23°C (73°F) and 50% RH. By extrapolation of the graph, it can be shown that at a stress level of 6.9MPa (1000 psi), the strain reaches a maximum of 2% after approximately 10 years (8.8x10<sup>4</sup> hours). As the tensile strength of **PA66 (Nylon 6.6.)** is 83MPa (12000psi), tightening the hose clamp to a slightly higher level during installation, will more than compensate for any subsequent creep.

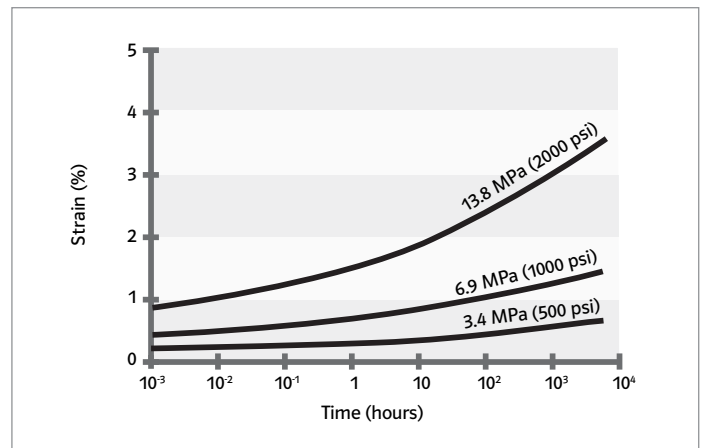

#### Fatigue

If materials are subjected to cyclical loading, they may be vulnerable to fatigue. The graph to the right shows axial fatigue for heat stabilised **PA66 (Nylon 6.6.)**. Test bars underwent 1800 cycles per minute of alternate tension and compression loading at 23°C (73°F).

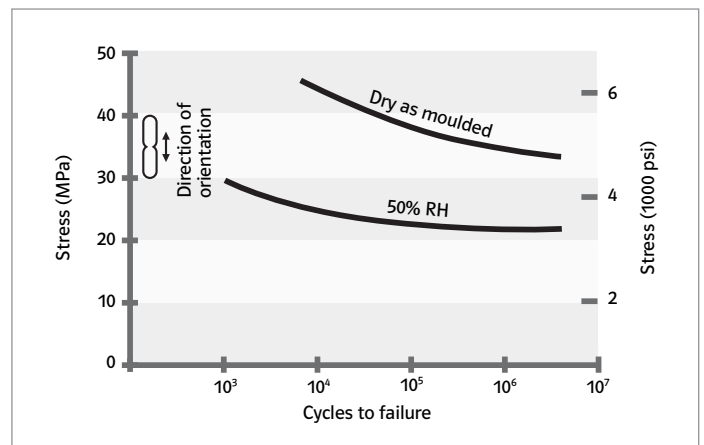

## Weathering

When exposed to weathering, polymers have a natural tendency to photo-oxidise and depolymerise to their natural elemental forms. There are variations in natural weathering depending on the intensities of the following components:

- Solar Radiation (UV)
- Moisture
- Heat
- Pollutants (to the polymer), e.g. ozone and acid rain
- Salt Water

The combination of more than one of these factors can also lead to accelerated degradation and aging.

Weathering intensity varies widely around the world, and may also vary from year to year for a given location, depending on weather patterns. Weather in a subtropical climate, such as Florida, may have twice the effect on a polymer as a more northerly location. A drier climate, such as Arizona, may have increased UV radiation, but because of the lower humidity, the effects of weathering on a polymer will not be so severe. It is impossible to give a precise indication of the effects of weathering in a given location, but by using natural outdoor and accelerated tests, certain predictions can be made.



HCL's plastic hose clamps are primarily manufactured from black heat stabilised **PA66 (Nylon 6.6.)**, whilst **PA66 GF30 (Nylon 6.6. 30% Glass-filled)** and **PP (Polypropylene)** are available on request. The carbon black additive acts as a very good UV stabiliser, and the heat stabiliser, usually copper based, provides further protection against photo-oxidative degradation by shutting down free radicals. This combination of inhibitors helps to give the polymers many years of life.

The following table provides an estimated life expectancy for polymers, which are exposed to weathering:

Materials all black	Life in Hot climates	Life in Temperate Climates
	YRS - Approx	YRS - Approx
PA66 (Nylon 6.6.)	10+	15+
PA66 GF (Glass-filled Nylon 6.6.)	10+	15+
PP (Polypropylene)	5+	8+



## Weathering

Compared with other polymers, **PA66 (Nylon 6.6.)** naturally exhibits a high resistance to weathering and UV degradation, even in its neat state. The graphs below, show the reduction in Tensile strength and the reduction in Elongation at break, of **PA66 (Nylon 6.6.)**, over a 2000 hour period in a weathering chamber. The accelerated weathering is achieved by wet and dry cycles and continuous UVA (320nm) exposure. The dry cycles last for 8 hours at 70°C, and the wet cycles for 4 hours.

### PA66 (Nylon 6.6.) – reduction in Tensile strength due to accelerated weathering

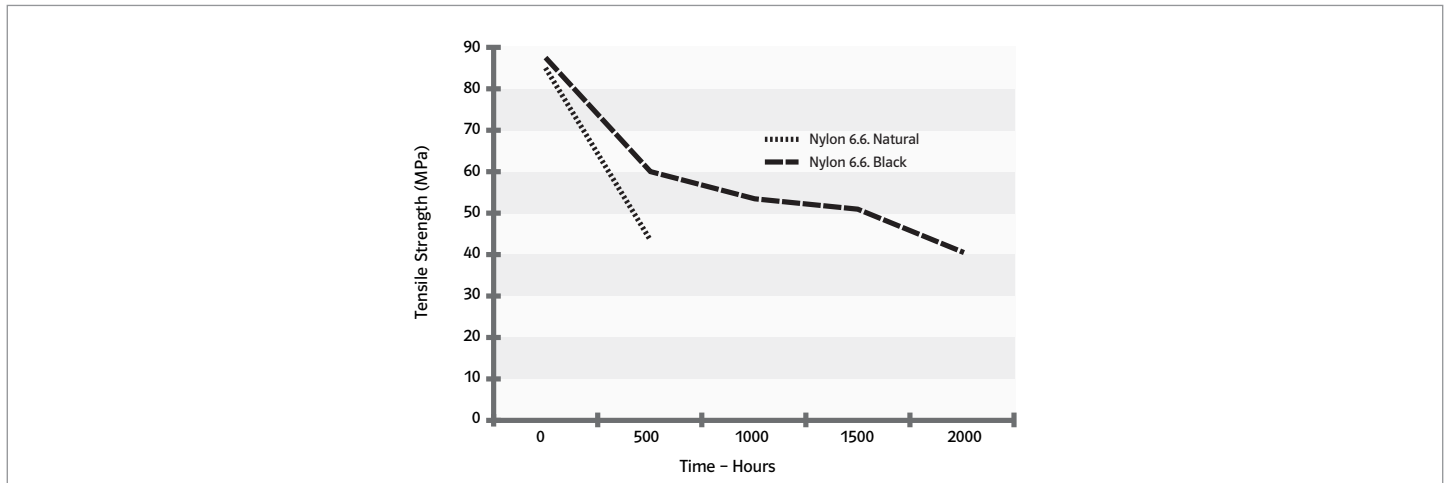

### PA66 (Nylon 6.6.) – reduction in Elongation at break due to accelerated weathering

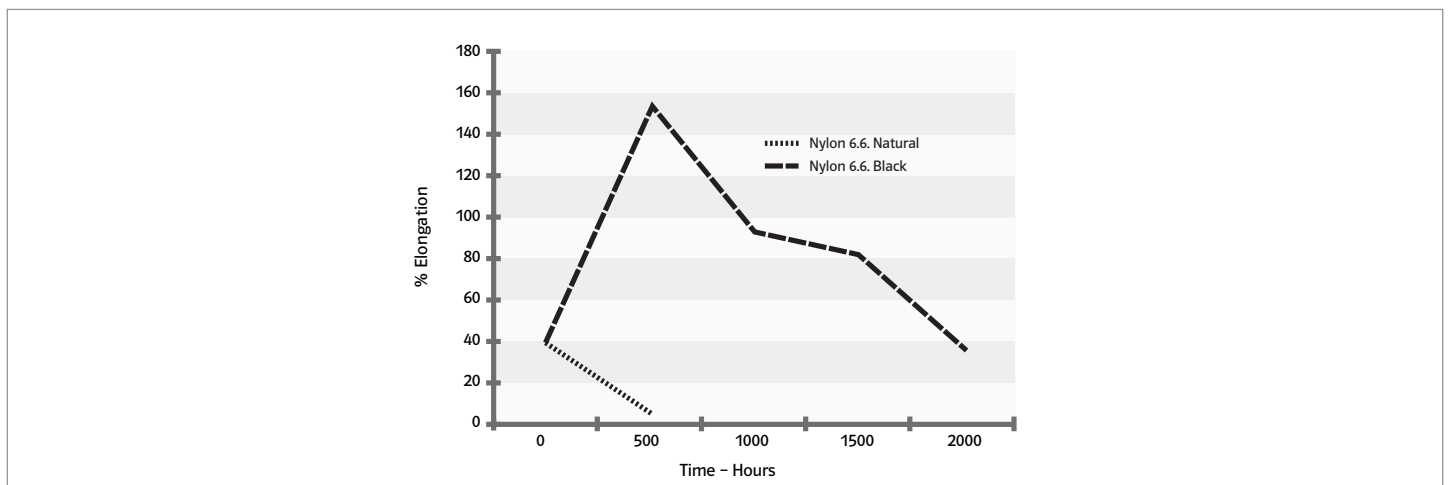

## Conclusion

- The degradation caused by weathering, in both the black and natural **PA66 (Nylon 6.6.)** tends to reduce the Tensile strength and the Elongation at break of the material over time. This makes the polymer weaker and more brittle.
- The carbon black UV stabiliser gives a huge increase in weathering resistance to **PA66 (Nylon 6.6.)**.
- It is important to note, that the sharp fall in Tensile strength and increase in Elongation at break from 0 - 500 hours, is largely due to a conditioning effect (taking on moisture). However, the UV degradation that occurs in the natural material during this time is enough to annul the conditioning effect and to reduce the Elongation at break to almost zero.

## Chemical Resistance

The engineering polymers used in the manufacture of the HCL hose clamp range are specifically chosen because of their outstanding resistance to organic and inorganic substances. They are not affected by, nor do they affect: lubricating oils, greases, aliphatic and aromatic hydrocarbons including conventional fuels.

Chemical Agent	Concentration	PA66 (Nylon 6.6.) / PA66 GF30% (Nylon 6.6. 30% Glass-filled)		Concentration	PP (Polypropylene) Performance	
		Temp °C	Performance		20°C (68°F)	60°C (140°F)
<b>Mineral Acids</b>						
Boric acid	7%	24	P	Sat. Sol.	G	G
Carbonic acid	10%	24	G	Sat. Sol.	G	G
Chloroacetic acid	10%	24	P	Sol	L	P
Chlorosulphonic acid	10%	24	P	Tg-s	P	P
Chromic acid	10%	24	P	40%	L	L
Hydrochloric acid	2.5%	23	G	10%	G	G
	5%	77	P	30%	G	G
	10%	25	P	Gaseous	G	
Nitric acid	10%	23	P	10%	G	P
				65%	G	P
				100%	P	P
Perchloric acid	10%	24	P	20%	G	
Phosphoric acid	5%	98	P	30%	G	G
	50%			90%	G	G
	100%	38	P	Gaseous, Dry	G	
Sulphuric acid				Gaseous, Wet	L	
				10%	G	G
				50%	L	P
				80%	L	P
				98%	L	P
Sulphurous acid	30%	23	P	98%	L	P
	10%	23	P	100%	L	P
<b>Mineral Salts</b>						
Aluminium hydroxide	10%	23	L	Sat. Sol.	G	G
	10%	52	P			
Alumina sulphate	10%	23	L	Sat. Sol.	G	G
		52	P			
Ammonium carbonate	10%	23	L	100%	G	G
Ammonium chloride	10%	52	P	100%	G	G
Ammonium hydroxide	10%	23	G**	10%	G	G
	100%	70	P**	28%	G	G
				100%	L	
Ammonium sulphate				Sat. Sol.	G	G
				100%	L	
Antimony trichloride	10%	24	P	Sat. Sol.	G	G
Barium chloride				Sat. Sol.	G	G
Barium sulphate	10%	24	P			
	10%	24	G	Sat. Sol.	G	G
Barium Sulphide	10%	24	L	Sat. Sol.	G	G
Calcium arsenate				Sat. Sol.	G	G
Calcium chloride	5%	60	P	Sat. Sol.	G	G
Calcium hypochlorite	Sat. Sol.	35	P	Sat. Sol.	G	L
Calcium thiocyanate	50%		P			
Copper chloride	10%	24	P	Sat. Sol.	G	G
Copper sulphate				Sat. Sol.	G	G
Copper sulphite	10%	24	P	Sat. Sol.	G	G
Di-ammonium phosphate				Sat. Sol.	G	G
Hydrogen sulphide	Sat. Sol.	23	P	Gaseous, Dry	G	G
Magnesium chloride				Sat. Sol.	G	G
Potassium carbonate				Sat. Sol.	G	G
Potassium chloride	20%	98	G			
	90%	23	G	Sat. Sol.	G	G
	30%	98	L	Sat. Sol.	G	G
Potassium nitrate				Sat. Sol.	G	G
Potassium sulphate				Sat. Sol.	G	G
Potassium thiocyanate	Sat. Sol.		P	Sat. Sol.	G	G
Sodium carbonate	2%	35	G	Sat. Sol.	G	G
Sodium chloride				Sat. Sol.	G	G
Sodium hydroxide	10%	23	G			
	10%	70	P**	Sat. Sol.	G	G
Sodium nitrate	5%	24	G	Sat. Sol.	G	G
Sodium sulphate	90%	24	G	Sat. Sol.	G	G
Sodium sulphide	90%	24	G	Sat. Sol.	G	G
Sodium thiosulphate	25%			Sat. Sol.	G	G
Stannic chloride	10%	24	P**	Solution	G	G
Stannic sulphate	10%	24	P	Solution	G	G
Tricresyl Phosphate	100%	66	G			

## Chemical Resistance

Chemical Agent	Concentration	PA66 (Nylon 6.6.) /PA66 GF30% (Nylon 6.6. 30% Glass-filled)		Concentration	PP (Polypropylene) Performance	
		Temp °C	Performance		20°C (68°F)	60°C (140°F)
Zinc chloride				Sat. Sol.	G	G
<b>Mineral bases</b>						
Ammonia	Sat. Sol.	-33	G	Gaseous, Dry	G	G
	100%	24	G			
Ammonia solution				100%	G	G
	10%	24	P			
Sodium bicarbonate	50%	24	G	Sat. Sol.	G	G
<b>Other mineral bodies</b>						
Bleach (sodium hypochlorite)	5%	23	L	10%	G	G
				Sat. Sol.	G	G
Bromine	100%	24	P	Tg-g	P	P
Bromine water	25%	23	G**	Tg-l	P	P
Chlorine	100%	23	P	Tg-g	P	P
				100%	P	P
Chlorine water	Sol.	23	L	2%	G	L
	Sat. Sol.	23	P			
Chlorox	100%	23	G			
Fluorine				Sat. Sol.	G	
Hydrogen				Tg-g	G	
Hydrogen peroxide	3%	23	G	3%	G	G
	5%	43	P	10%	G	L
				30%	G	L
Mercury				Tg-l	G	G
Oxygen				Tg-l	G	
Potassium permanganate	5%	23	P	20%	G	G
Sea water				100%	G	G
Sulphur				100%	G	G
Water				100%	G	G
<b>Organic bases</b>						
Aniline				100%	G	G
Diethanolamine				Tg-l	G	
Pyridine				100%	L	L
Urea				Sat. Sol.	G	G
<b>Organic acids and anhydrides</b>						
Acetic acid	5%	23	P**	10%	G	G
				60%	G	L
Acetic anhydride				Liquid	G	
Benzoic acid	10%	23	P	Sat. Sol.	G	G
Butyric acid	10%	24	P			
Citric acid	10%	24	P	Sat. Sol.	G	G
Formic acid	100%	23	P	50%	G	L
				85%	G	L
Glycolic acid	70%		P	30%	G	
Lactic acid	10%	35	G	10%	G	G
				50%	G	G
				90%	G	G
Oleic acid				Tg-l	G	L
Oxalic acid				Sat. Sol.	G	L
Picric acid				Sat. Sol.	G	
Stearic acid				100%	G	
Tartaric acid				100%	G	G
Uric acid				Sat. Sol.	G	G
<b>Hydrocarbons</b>						
Benzene	100%	23	G	Tg-l	L	P
Butane				Tg-g	G	
Cyclohexane				Tg-l	G	
Decaline				Tg-l	P	P
Heptane				Tg-l	L	L
Hexadecane	10%	23	G**	Tg-l	L	L
Naphthalene				Work. Sol.	G	P
NUJOL	100%	70	G			
Propane				Tg-g	G	
Toluene	100%	50	G	Tg-l	L	P
Xylene			G	Tg-l	P	P
<b>Alcohols</b>						
Benzyl alcohol				Tg-l	G	L
Butanol	100%	50	G	Tg-l	G	L
Ethanol	100%	23	G**	100%	G	G
	100%	50	G**			
Ethylene glycol	50%	23	G	Tg-l	G	G
Glycerin				Tg-l	G	G
Glycol				100%	G	G
Methanol	100%	23	G**	Tg-l	G	
<b>Aldehydes and ketones</b>						
Acetone	100%	23	G	Tg-l	G	
	100%	50	G			
Acetaldehyde		52	L	Tg-l	G	
Formaldehyde	38%	23	G	40%	G	
Cyclohexanone				Tg-l	L	L
Methyl ethyl ketone				Tg-l	G	L
Methyl isobutyl ketone	100%	23	G			
Benzaldehyde				Tg-l	G	

## Chemical Resistance

Chemical Agent	Concentration	PA66 (Nylon 6.6.) /PA66 GF30% (Nylon 6.6. 30% Glass-filled)		Concentration	PP (Polypropylene) Performance	
		Temp °C	Performance		20°C (68°F)	60°C (140°F)
<b>Chlorinated solvents</b>						
AROCLOR 1242	100%	23	G			
Carbon tetrachloride	100%	23	G	Tg-1	P	P
	100%	50	G			
Dichloroethane	100%	66	G	Tg-1	P	
Hexafluoroisopropanol	100%	23	P			
Methyl bromide				Tg-1	G	G
Methyl chloride	100%	23	L	Tg-1	G	G
Methyl trichloride	100%	23	G	Tg-1	G	G
Methylene chloride	100%	23	L	100%	L	P
Tetrafluoropropane			L			
Trichloroethylene				100%	P	P
Trichloroethane	100%	72	G			
Phenols	5%	23	P	5%	G	G
<b>Various organic bodies</b>						
Carbon sulphide				Tg-1	P	L
Dibromoethane	100%	50	L			
Dimethyl formamide				Tg-1	G	G
Furfural				100%	P	P
Glucose				Sol.	G	G
Glycol chlorhydrine				30%	G	
Nitromethane	100%	23	G			
2-Nitropropane	100%	72	G			
<b>Salts, esters, ethers</b>						
Amyl acetate	100%	98	P	100%	L	
Butyl acetate				100%	L	P
Diethylene glycol	90%	24	G	Tg-1	G	G
Dimethyl ether				100%	P	
Dioctyl phosphate						
Dioctyl phthalate				Tg-1	L	
Ethyl acetate	100%	50	G	Tg-1	L	P
Fatty acid esters				100%	L	
Methyl acetate				Tg-1	G	G
Sulphuric ether				100%	L	
<b>Miscellaneous products</b>						
Antifreeze	100%	104	L	Work. Sol.	G	G
Automatic transmission fluid				Work. Sol.	G	L
Beer				Work. Sol.	G	
Brake Fluid				Work. Sol.	G	G
Cider				Work. Sol.	G	
Crude oil				Work. Sol.	L	L
Detergent				Liquid	G	
				Powder	G	
Diesel				Work. Sol.	L	
Fruit juice				Work. Sol.	G	G
Gasohol				Work. Sol.	P	P
Grease				Work. Sol.	G	L
Kerosene				Work. Sol.	L	L
Lanolin suspension	10%	35	G	Work. Sol.	G	L
Linseed Cake	100%	82	G	Work. Sol.	G	
Milk				Work. Sol.	G	G
Motor oil				Work. Sol.	G	L
Mustard				Work. Sol.	G	
Naphtha	100%	98	G**	Work. Sol.	L	L
Oil				Work. Sol.	G	L
Premium grade gasoline				Work. Sol.	P	P
Regular grade gasoline				Work. Sol.	P	P
Soap Cleanser				100%	G	G
Stearine				100%	G	
Turpentine				Tg-1	P	P
Vinegar				Work. Sol.	G	G
Wine				Work. Sol.	G	G

\*Discolouration occurs. \*\*Swelling action. G = Good. L = Limited. P = Poor.



## Sterilisation

In medical applications, it is common practice to sterilise the clamps before use. This is typically an aggressive process, and can lead to degradation of the polymer depending on the type of sterilisation and the polymer used.

The table below gives polymer resistance to commonly used sterilisation methods:

Material	Gamma Radiation	Ethylene Oxide	Autoclave
Nylon & Glass-filled Nylon	Physically compatible with commonly used sterilisation doses, but may discolour to brownish hue.	Very Good. Some susceptibility to oxidising agents	Very Good. Components may swell slightly due to water absorption
Polypropylene	Excellent up to commonly used sterilisation doses (approximately 6 M-Rad)	Fair. May stress crack in EtO/CFC mix due to moulding stresses	Poor. Parts may distort due to low heat deflection temperature.



## HCL's Quality Policy

Within HCL Fasteners Ltd we are committed to provide products and services which meet the customers' specified contractual and project requirements and those of all applicable regulating authorities.

We are totally committed to setting and achieving quality standards that are capable of meeting, in all respects, the specified requirements and reasonable expectations of our customers, whilst working within the framework of statutory, regulatory and legal requirements.

In order to achieve this objective, it is the policy of HCL Fasteners to maintain an effective quality system based on the requirements of: **BS EN ISO 9001-2008**.



## Goods Received Inspection

HCL's plastic hose clamps are made from polymers, such as Nylon 6.6. and Polypropylene, that are inspected on receipt from our suppliers, by the quality controller. The material is inspected for:

- Quality
- Type
- Satisfactory packaging

The Goods Inwards inspection information is logged and retained by the Quality Control Department. If the material passes this inspection satisfactorily, it is transferred to raw material stores.

## Injection Moulding Control

HCL's plastic hose clamps are manufactured to the highest standard using the latest equipment and techniques. The injection-moulding machines are computer controlled and the settings for each mould tool are recorded for maximum repeatability. Before a production run can begin, the first-off components must be checked and approved against their specification. The machines also have quality control capabilities where parameters, e.g. melt cushion, are given an acceptable tolerance range. If these parameters go out of tolerance, a quality flap automatically rejects the parts.

## Statistical Process Control

SPC data relating to each manufacturing batch is available

to customers upon request. This data is entered into a computer for dimensional verification and weight checks. The SPC sample and a hard copy of the SPC data are stored for reference and product traceability.

## Routine Production Checks

Clips found to be outside specification are rejected, and the batch concerned isolated. Settings are adjusted until satisfactory yield is achieved and the suspect batch subject to 100% inspection.

## Final Inspection

All products are given a final visual and physical inspection.

During packaging, quality is confirmed by:

- An inspection ticket packed with the goods.
- A Quality Assurance label attached to the outside of the packaging.

If required, a certificate of conformity to HCL's product specification can be issued.

## Quality Policy

HCL is committed to the highest possible quality standards. Quality control systems are subject to review at appropriate intervals in consideration of the following:

- Changes in technology
- Changes to markets
- Changes in legislation
- External assessor's reports
- Overall company facilities & policies