



PRODUCTS

STANDARD OIL DRAIN PLUG

Standard oil drain plug

The Standard Drain is the original Femco® oil drain plug, and was introduced in 1983 to change oil in a quick, clean and environmentally friendly way. The Standard Drain is manufactured out of 100% Brass, which makes it easy to change hot oil. Additionally the oil drain plugs are fitted with a dust cover and a double O-ring, which protect the plug and ensures a reliable performance.



Application: Engine oil, Hydraulic oil, Gearbox oil, Coolant, Lubricating oil

Material: Brass outside / Brass inside / Stainless steel spring

Temperature range: -20° / 200° Celsius

Valve: Brass with Viton O-ring / Valve

Dust cap: Brass, Thread size LB: M26x1,5 / SB: 22x1.5

Dust cap seal: NBR O-ring

Body seal: Viton O-ring

HOW TO DRAIN YOUR OIL (OR OTHER FLUIDS)

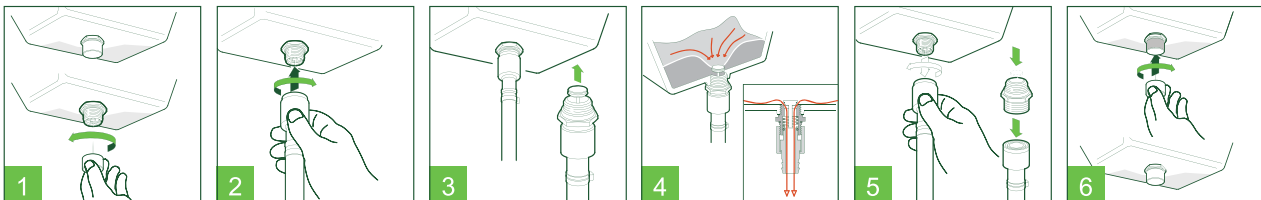

For all sizes not mentioned,
please contact us for a free quote

**STANDARD DRAIN SB
PRODUCT SPECIFICATIONS**

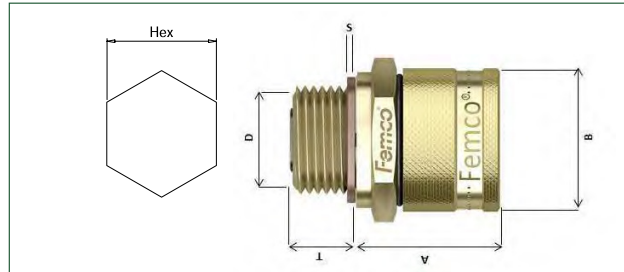

Metric sizes						
Thread size (D)		T	A	B	S	Hex
M12x1.0	6090010001	9	27	25	2	22
M12x1.25	6090010002	9	27	25	2	22
M12x1.25	6090010011	12	24	25	2	22
M12x1.5	6090010003	9	27	25	2	22
M12x1.5	6090010019	12	24	25	2	22
M12x1.5	6090010031	18	27	25	2	22
M12x1.5	6090010033	25	27	25	2	22
M12x1.75	6090010004	9	27	25	2	22
M12x1.75	6090010020	14	27	25	2	22
M12x1.75	6090010034	17	27	25	2	22
M12x1.75	6090010027	25	27	25	2	22
M14x1.25	6090010005	9	27	25	2	22
M14x1.25	6090010009	12	24	25	2	22
M14x1.25	6090010035	16	27	25	2	22
M14x1.5	6090010007	9	27	25	2	22
M14x1.5	6090010008	11.5	27	25	2	22
M14x1.5	6090010021	12	24	25	2	22
M14x1.5	6090010016	14	27	25	2	22
M14x1.5	6090010006	16	27	25	2	22
M14x1.5	6090010037	18	27	25	2	22
M14x1.5	6090010022	21	27	25	2	22
M14x2.0	6090010010	9	27	25	2	22
M16x1.5	6090010012	9	27	25	2	22
M16x1.5	6090010029	10	32	25	2	22
M16x1.5	6090010013	12	24	25	2	22
M16x1.5	6090010044	14	27	25	2	22
M18x1.5	6090010014	9	27	25	2	24
M18x1.5	6090010015	12	24	25	2	24
M20x1.0	6090010017	10	27	25	2	27
M20x1.5	6090010018	10	27	25	2	27
M20x1.5	6090010040	14	27	25	2	22
M22x1.5	6090010025	7	29	25	1.5	27
M22x1.5	6090010023	10	27	25	1.5	27
M22x1.5	6090010024	12	24	25	1.5	27
M22x1.5	6090010025	15	24	25	1.5	27

NPT						
Thread size (D)		T	A	B	S	Hex
1/2"-14-NPT	60600100108	10	27	25		27
1/4"-18-NPT	60600100106	9	27	25		27
3/8"-18-NPT	60600100107	9	27	25		27

BSP						
Thread size (D)		T	A	B	S	Hex
1/4"-19-BSP	6070010102	9	27	25	2	22
3/8"-19-BSP	6070010103	8.5	28	25	2	22
3/8"-19-BSP	6070010131	10	27	25	2	22
3/8"-19-BSP	6070010104	12	27	25	2	22
1/2"-14-BSP	6070010100	10	27	25	2	27
3/4"-14-BSP	6070010134	10	27	25	2	27

UNF						
Thread size (D)		T	A	B	S	Hex
1/2"-20-UNF	6080010095	14	27	25	2	27
1/2"-20-UNF	6080010087	10	27	25	2	27
1/2"-20-UNF	6080010084	20	27	25	2	27
1/2"-20-UNF	6080010083	30	27	25	2	27
9/16"-18-UNF	6080010089	9	32	30	2	30
5/8"-18-UNF	6080010090	9	32	30	2	30
5/8"-18-UNF	6080010088	12	27	25	2	27
3/4"-16-UNF	6080010092	10	27	25	2	27
3/4"-16-UNF	6080010093	15	27	25	2	27
3/4"-16-UNF	6080010097	22	27	25	2	27

For all sizes not mentioned, please contact us for a free quote

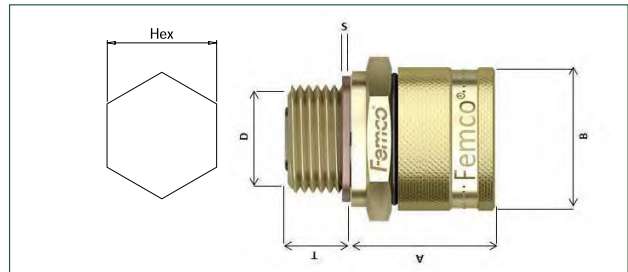

Metric. Sizes

Thread size (D)		T	A	B	S	Hex
M12x1.25	6090020029	10	32	30	2	30
M12x1.25	6090020026	12	32	30	2	30
M12x1.5	6090020030	10	32	30	2	30
M12x1.75	6090020031	10	32	30	2	30
M12x1.75	6090020022	14	32	30	2	30
M12x1.75	6090020085	17	32	30	2	30
M12x1.75	6090020024	25	32	30	2	30
M14x1.25	6090020032	10	32	30	2	30
M14x1.25	6090020027	12	32	30	2	30
M14x1.5	6090020033	10	32	30	2	30
M14x1.5	6090020034	16	32	30	2	30
M14x1.5	6090020060	20	32	30	2	30
M16x1.5	6090020036	10	32	30	2	30
M16x1.5	6090020023	14	32	30	2	30
M18x1.5	6090020025	12	32	30	2	30
M18x1.5	6090020038	10	32	30	2	30
M18x1.5	6090020037	14	32	30	2	30
M18x1.5	6090020039	15	32	30	2	30
M18x1.5	6090020084	19	32	30	2	30
M20x1.5	6090020040	10	32	30	2	30
M20x1.5	6090020067	14	32	30	2	30
M20x1.5	6090020044	15	32	30	2	30
M22x1.5	6090020045	7	35	30	2	30
M22x1.5	6090020046	10	32	30	2	30
M22x1.5	6090020047-01	12	32	30	2	30
M22x1.5	6090020048	13	34	30	2	30
M22x1.5 42L	6090020049	15	34	30	2	30
M22x1,5 42L	6090020050	17	30	30	2	30
M22x1,5	6090020051	17	30	30	2	30
M22x1,5	6090020052	30	27	30	2	30
M24x1.5	6090020053	10	30	30	2	30
M24x1.5	6090020054	12	30	30	2	30
M24x1,5	6090020055	15	27	30	2	30

M24x2.0	6090020056	10	30	30	2	30
M24x2.0	6090020057	12	30	30	2	30
M24x2.0	6090020058	21	30	30	2	30
M24x2.0	6090020059	35	30	30	2	30
M25x1.5	6090020069	13	32	30	2	32
M25x1.5	6090020061	15	27	30	2	32
M25x1.5 47L	6090020062	15	27	30	2	32
M26x1.5	6090020063	10	32	30	2	32
M26x1.5	6090020072	16	32	30	2	32
M26x1,5 37L	6090020064	17	25	30	2	32
M26x1.5	6090020065	17	35	30	2	32
M26x1.75	6090020073	10	35	30	2	32
M26x2.0	6090020088	10	35	30	2	32
M27x2.0	6090020070	12	30	30	2	32
M27x2.0	6090020071	12	30	30	O-ring	32
M30x1.5	6090020074	10	32	30	2	36
M30x2.0	6090020077	12	32	30	2	36
M32x1.5	6090020078	12	32	30	2	38
M32x2.0	6090020079	12	32	30	2	38
M36x1.5	6090020081	12	32	30	2	42
M36x2.0	6090020082	12	32	30	2	42
M38x1.5	6090020083	12	32	30	2	46

For all sizes not mentioned,
please contact us for a free quote

**STANDARD DRAIN LB
 PRODUCT SPECIFICATIONS**

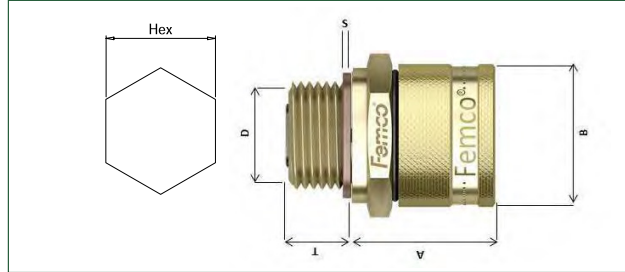

BSP						
Thread size (D)		T	A	B	S	Hex
1/4"-19-BSP	6070020130	10	32	30	2	30
3/8"-19-BSP	6070020131	10	32	30	2	30
1/2"-14-BSP	6070020132	10	32	30	2	30
3/4"-14-BSP	6070020134	10	32	30	2	32
3/4"-14-BSPT	6070020142	15	32	30	2	32
1"-11-BSP	6070020141	12	32	30	2	36
1"-11-BSPT	6070020146	15	32	30	2	36
1 1/2"-11-BSP	6070020144	12	30	30	2	60

NPT						
Thread size (D)		T	A	B	S	Hex
1/4"-18-NPT	6060020143	10	32	30		30
1/2"-14-NPT	6060020143	12	32	30		30
1/2"-14-NPT	6060020139	15	32	30		30
1/2"-14-NPT	6060020138	24	32	30		30
1"-11.5-NPT	6060020145	12	32	30		36
3/8"-18-NPT	6080020142	10	32	30		32
3/4"-14-NPT	6060020140	12	32	30		32
3/4"-14-NPT	6060020144	15	32	30		32

UNF						
Thread size (D)		T	A	B	S	Hex
1/2"-20-UNF	6080020136	12	32	30	2	30
1/2"-20-UNF	6080020108	20	32	30	2	30
1/2"-20-UNF	6080020107	30	32	30	2	30
1/2"-20-UNF	6080020109	10	32	30	2	30
3/4"-16-UNF	6080020113	10	32	30	2	30
3/4"-16-UNF	6080020114	15	32	30	2	30
3/4"-16-UNF	6080020106	22	32	30	2	30
7/8"-14-UNF	6080020115	10	32	30	2	30
7/8"-18-UNF	6080020118	10	32	30	2	30
7/8"-20-UNF	6080020119	10	32	30	2	30
1"-12-UNF	6080020120	12	30	30	2	32
1"-14-UNF	6080020121	12	32	30	2	32
1 1/16"-12-UNF	6090020122	15	30	30	2	32
1 5/16"-12-UNF	6080020125	12	32	30	2	32
1 1/8"-12-UNF	6080020123	15	30	30	2	36
1 1/16"-12-UNF	6080020122	15	30	30	2	32
1 1/16"-12-UNF	6080020132	15	27	30	2	32
1 1/16"-12-UNF	6080020134	25	27	30	3	32
1 1/16"-12-UNF	6080020131	25	27	30	O-ring	32
1 1/4"-12-UNF	6080020133	12	32	30	2	36
1 5/16"-12-UNF	6080020125	12	32	30	2	36
1 1/8"-12-UNF	6080020123	15	30	30	2	36
1 1/2"-12-UNF	6080020128	12	32	30	2	46
2"-12-UNF	6080020129	12	30	30	2	60

UNS						
Thread size (D)		T	A	B	S	Hex
1"-18-UNS	6060020148	12	32	30	2	32
1"-18-UNS	6060020149	25	30	30	2	32

For all sizes not mentioned, please contact us for a free quote

Straight Drainers

Description		Connection	Hose (mm)
Straight Drainer	650117	M22x1.5	
Straight Drainer with hose	650100	M22x1.5	250
Straight Drainer with hose	650101	M22x1.5	1300

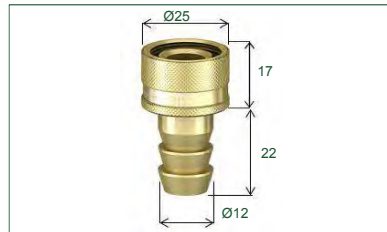

Angled Drainers 90°

Description		Connection	Hose (mm)
Angled Drainers 90°	650119	M22x1.5	
Angled Drainers 90° with hose	650106	M22x1.5	250
Angled Drainers 90° with hose	650107	M22x1.5	1300

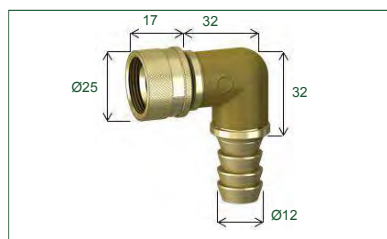

Hose

Description		Size	(mm)
Clamp	951004	1/2"	
Hose	101096	12x16 - 1/2"	250
Hose	101098	12x16 - 1/2"	1300

Dust Caps

Description		Connection
Dust cap	650112	M22x1.5
Dust cap + Chain	650116	M22x1.5

Sampling nipple

Description	
Sampling nipple	951006

For all sizes not mentioned,
please contact us for a free quote

Straight Drainers

Description		Connection	Hose (mm)
Straight Drainer	650118	M26x.1.5	
Straight Drainer with hose	650103	M26x.1.5	250
Straight Drainer with hose	650104	M26x.1.5	1300

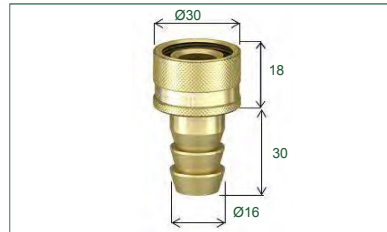

Angled Drainers 90°

Description		Connection	Hose (mm)
Angled Drainers 90°	650120	M26x.1.5	
Angled Drainers 90° with hose	650108	M26x.1.5	250
Angled Drainers 90° with hose	650109	M26x.1.5	1300

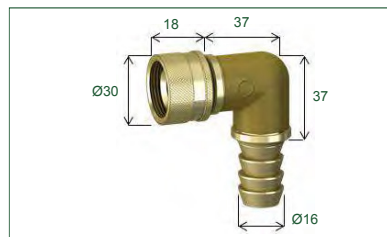

Angled Drainers 45°

Description		Connection	Hose (mm)
Angled Drainers 45°	650123	M26x.1.5	
Angled Drainers 45° with hose	650121	M26x.1.5	250
Angled Drainers 45° with hose	650122	M26x.1.5	1300

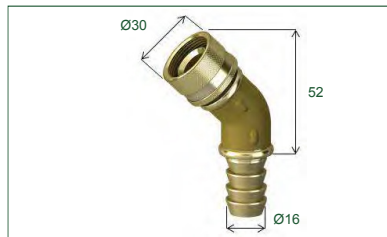

Sampling nipple

Description	
Sampling nipple	951007

Dust Caps

Description		Connection
Dust cap	650135	M26x1.5
Dust cap + Chain	650113	M26x1.5

Hose

Description		Size	(mm)
Clamp	951005	3/4"	
Hose	101095	18x23 - 3/4"	250
Hose	101097	18x23 - 3/4"	1300

For all sizes not mentioned, please contact us for a free quote

Compact oil drain plug

The Compact Drain is the smallest oil drain plug we produce, and is the perfect choice for oil changes in tight spaces. The Compact plug only extends 12 millimetres from the sump, and is often used in vehicles with a low ground clearance such as cars, busses and motorcycles. You can install the Compact on any vehicle without worrying about the available space.



Application: Engine oil, Hydraulic oil, Gearbox oil, Coolant, Lubricating oil

Material: Brass outside / Brass inside / Stainless steel spring

Temperature range: -20° / 200° Celsius

Valve: Brass with Viton O-ring / Valve

Dust cap: Brass, Thread size LB: M24x1,5 / SB: 20x1.5

Dust cap seal: NBR O-ring

Body seal: Viton O-ring

HOW TO DRAIN YOUR OIL (OR OTHER FLUIDS)

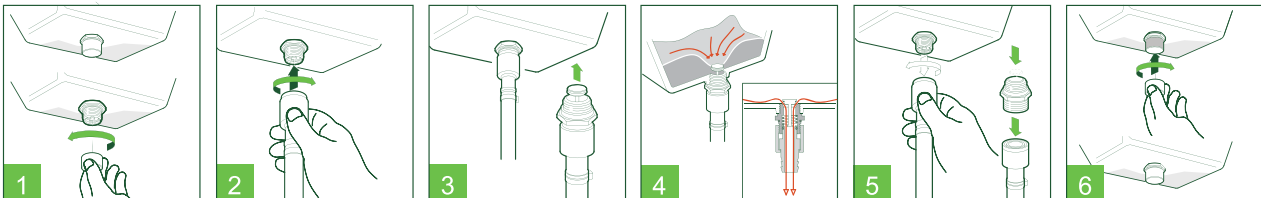

**COMPACT DRAIN SB
PRODUCT SPECIFICATIONS**

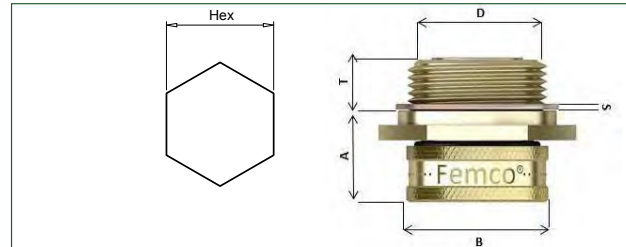

Metric.sizes						
Thread size (T)		L	A	B	S	Hex
M12x1.25	7090010151	9	13	24	2	22
M12x1.25	7090010146	12	12	24	2	30
M12x1.5	7090010152	9	13	24	2	22
M12x1.5	7090010148	12	12	24	2	30
M12x1.5	7090010147	13	12	24	2	30
M12x1.5	7090010144	18	12	24	2	30
M12x1.5	7090010142	25	12	24	2	30
M12x1.75	7090010153	9	13	24	2	22
M12x1.75	7090010150	12	12	24	2	30
M12x1.75	7090010149	14	12	24	2	30
M12x1.75	7090010174	18	12	24	2	30
M12x1.75	7090010145	25	12	24	2	30
M14x1.25	7090010154	9	13	24	2	22
M14x1.5	7090010156	9	13	24	2	22
M14x1.5	7090010155	12	12	24	2	30
M14x1.5	7090010157	14	12	24	2	30
M14x1.5	7090010159	16	12	20	2	30
M14x1.5	7090010138	18	12	24	2	30
M16x1.5	7090010161	9	13	24	2	22
M16x1.5	7090010162	12	12	24	2	30
M18x1.5	7090010163	9	13	24	2	24
M18x1.5	7090010136	12	12	24	2	30
M18x1.5	7090010135	19	12	24	2	30
M20x1.5	7090010167	10	13	24	2	27
M20x1.5	7090010134	14	12	24	2	30
M20x2.5	7090010170	10	12	24	2	27
M22x1.5	7090010172	10	13	24	1.5	27
M22x1.5	7090010173	12	12	24	2	30

BSP						
Thread size (T)		L	A	B	S	Hex
1/4"-19-BSP	7070010346	9	13	24	2	22
3/8"-19-BSP	7070010347	9	13	24	2	22
1/2"-14-BSP	7070010348	10	13	24	2	27

NPT						
Thread size (T)		L	A	B	S	Hex
1/4"-18-NPT	7060010350	9	12	24		22
3/8"-18-NPT	7060010352	9	12	24		22
1/2"-14-NPT	7060010353	10	12	24		27

UNF						
Thread size (T)		L	A	B	S	Hex
5/8"-18-UNF	7080010337	9	12	24	2	22
5/8"-18-UNF	7080010338	12	12	24	2	22
9/16"-18-UNF	7080010336	9	12	24	2	22
1/2"-20-UNF	7080010334	9	12	24	2	22
1/2"-20-UNF	7080010332	12	12	24	2	22
1/2"-20-UNF	7080010331	20	12	24	2	22
1/2"-20-UNF	7080010330	30	12	24	2	22
3/4"-16-UNF	7080010339	10	12	24	2	27
3/4"-16-UNF	7080010340	15	12	24	2	24
3/4"-16-UNF	7080010344	22	12	24	2	27

For all sizes not mentioned,
please contact us for a free quote

COMPACT DRAIN LB
PRODUCT SPECIFICATIONS

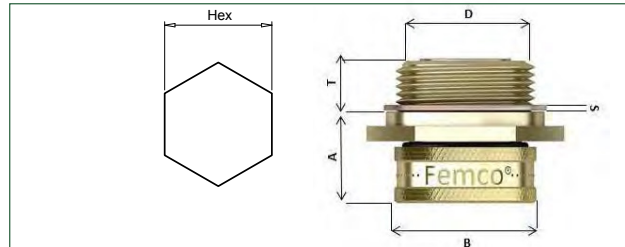

Metric. Sizes

Thread size (D)		T	A	B	S	Hex
M12x1.25	7090020176	12	13	28	2	30
M12x1.25	7090020177	10	13	28	2	30
M12x1.5	7090020178	10	12	28	2	30
M14x1.25	7090020179	12	13	28	2	30
M14x1.25	7090020180	10	12	28	2	30
M14x1.25	7090020185	12	13	28	2	30
M14x1.5	7090020181	10	12	28	2	30
M14x1.5	7090020190	20	13	28	2	30
M14x1.5	7090020338	12	13	28	2	30
M15x1.5	7090020174	12	13	28	2	30
M16x1.5	7090020184	10	13	28	2	30
M16x1.5	7090020175	14	13	28	2	30
M18x1.5	7090020186	10	13	28	2	30
M18x1.5	7090020196	19	13	28	2	30
M20x1.5	7090020189	10	13	28	2	30
M20x1.5	7090020201	14	13	28	2	30
M22x1.5	7090020195	10	13	28	2	30
M22x1.5	7090020207	12	13	28	2	30
M22x1.5	7090020198	15	13	28	2	30
M22x1.5	7090020199	19	13	28	2	30
M24x1.5	7090020203	12	13	28	2	30
M24x1.5	7090020334	14	14	28	2	30
M24x1.5	7090020204	15	13	28	2	30
M24x1.5	7090020205	16	13	28	2	30
M24x2.0	7090020208	11	13	28	2	30
M24x2.0	7090020224	12	15	28	2	30
M24x2.0	7090020488	21	13	28	2	30
M25x1.5	7090020209	13	13	28	2	32
M25x1.5	7090020210	15	13	28	2	32
M26x1.5	7090020212	10	13	28	2	32
M26x1.5	7090020211	16	13	28	2	32
M27x1.75	7090020217	12	15	28	2	32
M27x2.0	7090020216	12	14	28	2	32

M30x1.5	7090020220	10	13	28	2	36
M30x1.5	7090020335	10	18	28	2	36
M32x1.5	7090020227	12	13	28	2	38
M36x1.5	7090020336	12	15	28	2	42
M36x2.0	7090020228	12	13	28	2	42

BSP

Thread size (D)		T	A	B	S	Hex
1/4"-19-BSP	7070020395	10	13	28	2	30
3/8"-19-BSP	7070020396	10	14	28	2	30
1/2"-14-BSP	7070020397	10	13	28	2	30
3/4"-14-BSP	7070020399	12	15	28	2	32
1"-11-BSP	7070020401	12	15	28	2	36
1/2"-14-BSPT	7070020398	12	13	28	2	30

NPT

Thread size (D)		T	A	B	S	Hex
1/4"-18-NPT	7060020406	10	13	28		32
1/2"-14-NPT	7060020408	12	13	28		30
1/2"-14-NPT	7060020414	15	13	28		30
1/2"-14-NPT	7060020415	24	13	28		32
3/4"-14-NPT	7060020409	12	15	28		32
3/4"-14-NPT	7060020411	15	13	28		32
3/4"-14-NPT	7080020418	16	13	28		32
3/8"-18-NPT	7060020407	10	12	28		30
1"-11.5-NPT	7060020413	12	15	28		30

For all sizes not mentioned,
please contact us for a free quote

**COMPACT DRAIN LB
 PRODUCT SPECIFICATIONS**

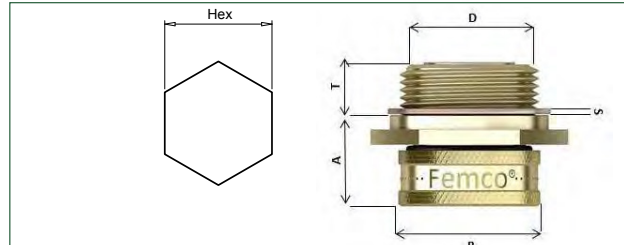

UNF						
Thread size (D)		T	A	B	S	Hex
1/2"-20-UNF	7080020354	10	13	28	2	30
1/2"-20-UNF	7080020392	12	13	28	2	30
1/2"-20-UNF	7080020357	20	14	28	2	30
1/2"-20-UNF	7080020356	30	14	28	2	30
3/4"-16-UNF	7080020358	10	13	28	2	30
3/4"-16-UNF	7080020359	15	12	28	2	30
7/8"-14-UNF	7080020360	10	13	28	2	30
7/8"-18-UNF	7080020363	10	13	28	2	30
7/8"-20-UNF	7080020364	10	14	28	2	30
1"-12-UNF	7080020366	12	15	28	2	32
1"-14-UNF	7080020367	12	15	28	2	32
1"-18-UNF	7080020417	22	13	28	2	32
1 1/16"-12-UNF	7080020377	12	15	28	2	32
1 1/16"-12-UNF	7080020386	15	14	28	2	32
1 1/8"-12-UNF	7080020378	12	15	28	2	36
1 1/8"-12-UNF	7080020387	15	14	28	2	32
1 5/16"-12-UNF	7080020372	12	15	28	2	36
1 5/16"-12-UNF	7080020390	12	13	28	2	36
1 1/2"-12-UNF	7080020355	12	14	28	2	46

UNS						
Thread size (D)		T	A	B	S	Hex
1"-18-UNS	7050020417	12	15	28	2	32

For all sizes not mentioned,
 please contact us for a free quote

Straight Drainers

Description		Connection	Hose (mm)
Straight Drainer	750003	M20x.1.5	
Straight Drainer with hose	750001	M20x.1.5	250
Straight Drainer with hose	750002	M20x.1.5	1300

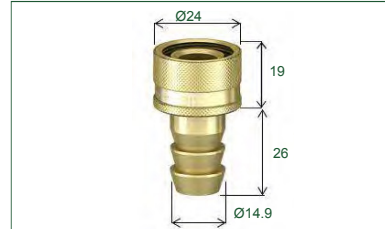

Angled Drainers 90°

Description		Connection	Hose (mm)
Angled Drainers 90°	750009	M20x.1.5	
Angled Drainers 90° with hose	750004	M20x.1.5	250
Angled Drainers 90° with hose	750008	M20x.1.5	1300

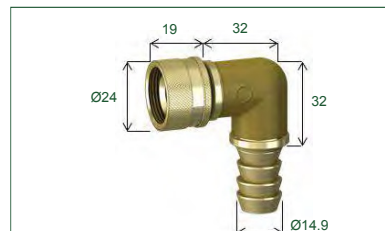

Angled Drainers 90° Special

Description		Connection	Hose (mm)
Angled Drainers 90°	750029	M20x.1.5	
Angled Drainers 90° with hose	750030	M20x.1.5	250
Angled Drainers 90° with hose	750031	M20x.1.5	1300

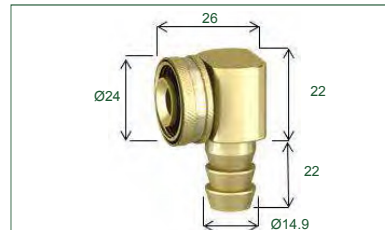

Hose

Description		Size	(mm)
Clamp	951004	1/2"	
Hose	101096	12x16 - 1/2"	250
Hose	101098	12x16 - 1/2"	1300

Dust Caps

Description		
Dust cap	750027	M20x1.5

Sampling nipple

Description	
Sampling nipple	951008

For all sizes not mentioned,
 please contact us for a free quote

Straight Drainers

Description		Connection	Hose (mm)
Straight Drainer	750007	M26x1.5	
Straight Drainer with hose	750008	M26x1.5	250
Straight Drainer with hose	750009	M26x1.5	1300

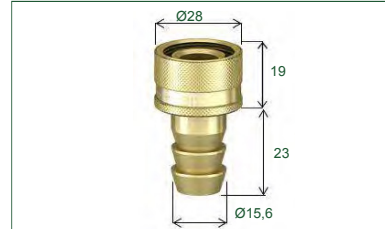

Angled Drainers 90°

Description		Connection	Hose (mm)
Angled Drainers 90°	750012	M26x1.5	
Angled Drainers 90° with hose	750010	M26x1.5	250
Angled Drainers 90° with hose	750011	M26x1.5	1300

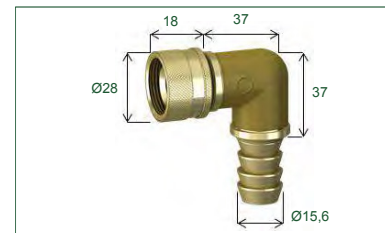

Angled Drainers 45°

Description		Connection	Hose (mm)
Angled Drainers 45°	7500026	M26x1.5	
Angled Drainers 45° with hose	7500013	M26x1.5	250
Angled Drainers 45° with hose	7500014	M26x1.5	1300



Angled Drainers 90° Special

Description		Connection	Hose (mm)
Angled Drainers 90°	750032	M26x1.5	
Angled Drainers 90° with hose	750033	M26x1.5	250
Angled Drainers 90° with hose	750034	M26x1.5	1300

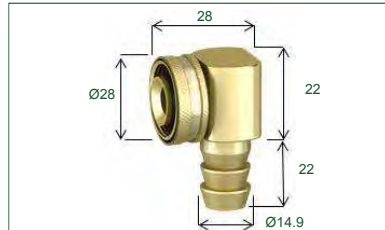

Sampling nipple

Description	
Sampling nipple	951009



Dust Caps

Description		Connection
Dust cap	750028	M24x1.5



Hose

Description		Size	(mm)
Clamp	951005	3/4"	
Hose	101095	18x23 - 3/4"	250
Hose	101097	18x23 - 3/4"	1300

For all sizes not mentioned, please contact us for a free quote

Click Drain Plug

The Click Drain the quickest solution for maintenance on your vehicles and machines. The Click Drain oil drain system consists of an oil drain plug and a clicker. When it is time for an oil change you simply have to click the Clicker onto the oil drain plug to start draining the oil. The Click Drain plug is often used in combination with the Femco® Oil Extractor Pump and is the ideal solution for small maintenance at fleets of vehicles.



Application: Engine oil, Hydraulic oil, Gearbox oil, Coolant, Lubricating oil

Material: Brass outside / Brass inside / Stainless steel spring

Temperature range: -20° / 200° Celsius

Valve: Brass with Viton O-ring / Valve

Dust cap: Brass, Thread size LB: M26x1,5 / SB: 22x1.5

Dust cap seal: NBR O-ring

Body seal: Viton O-ring

HOW TO DRAIN YOUR OIL (OR OTHER FLUIDS)

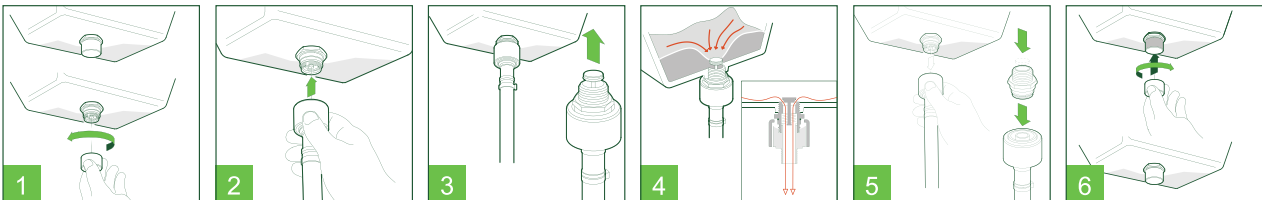

**CLICK DRAIN SB
PRODUCT SPECIFICATIONS**

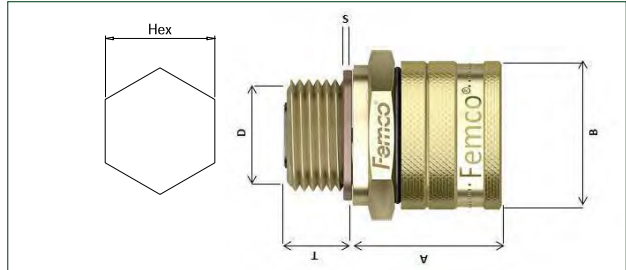
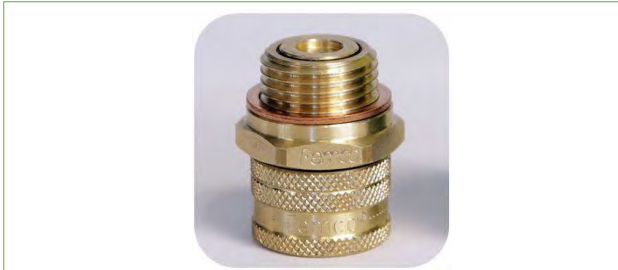

Metric sizes

Thread size (T)		T	A	B	S	Hex
M12x1.25	8090010049	9	27	25	2	22
M12x1.25	8090010050	12	27	25	2	22
M12x1.5	8090010044	9	27	25	2	22
M12x1.5	8090010051	12	27	25	2	22
M12x1.5	8090010047	18	27	25	2	22
M12x1.75	8090010421	9	27	25	2	22
M12x1.75	8090010043	17	27	25	2	22
M12x1.75	8090010045	25	27	25	2	22
M12x1.75	8090010048	25	27	25	2	22
M14x1.25	8090010422	9	27	25	2	22
M14x1.25	8090010053	12	27	25	2	22
M14x1.25	8090010053	12	27	25	2	22
M14x1.25	8090010055	16	27	25	2	22
M14x1.5	8090010423	9	27	25	2	22
M14x1.5	8090010420	12	27	25	2	22
M14x1.5	8090010424	14	27	25	2	22
M14x1.5	8090010425	16	27	25	2	22
M14x1.5	8090010057	18	27	25	2	22
M14x1.5	8090010058	20	27	25	2	22
M16x1.5	8090010443	14	27	25	2	22
M16x1.5	8090010426	9	27	25	2	22
M16x1.5	8090010427	10	26	25	2	22
M16x1.5	8090010431	12	27	25	2	22
M18x1.5	8090010428	9	27	25	2	24
M18x1.5	8090010429	12	24	25	2	24
M18x1.5	8090010433	14	24	25	2	24
M18x1.5	8090010059	19	27	25	2	24
M20x1.5	8090010430	10	27	25	2	27
M20x1.5	8090010060	14	27	25	2	27
M20x2.0	8090010432	10	27	25	2	27
M22x1.5	8090010436	7	29	25	2	27
M22x1.5	8090010439	10	27	25	2	27
M22x1.5	8090010440	12	24	25	2	27

BSP

Thread size (T)		T	A	B	S	Hex
1/4"-19-BSP	8080010500	9	27	25	2	22
3/8"-19-BSP	8080010501	9	27	25	2	22
1/2"-14-BSP	8080010502	10	27	25	2	27

NPT

Thread size (T)		T	A	B	S	Hex
1/4"-18-NPT	8060010511	10	27	25		27
3/8"-18-NPT	8060010512	9	27	25		22
1/2"-14-NPT	8060010513	10	27	25		27

UNF

Thread size (T)		T	A	B	S	Hex
1/2"-20-UNF	8080010477	9	27	25	2	22
9/16"-18-UNF	8080010478	9	27	25	2	27
5/8"-18-UNF	8080010479	9	27	25	2	27
3/4"-16-UNF	8080010445	22	27	25	2	27
3/4"-16-UNF	8080010482	15	27	25	2	27
3/4"-16-UNF	8080010481	10	27	25	2	27
3/4"-16-UNF	8080010481	10	27	25	2	27

For all sizes not mentioned, please contact us for a free quote

CLICK DRAIN LB
PRODUCT SPECIFICATIONS

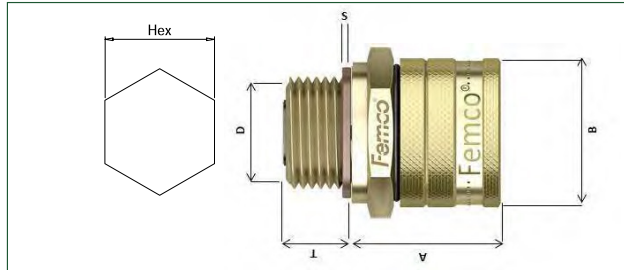

Metric sizes

Thread size (D)		T	A	B	S	Hex
M12x1.25	8090020419	10	32	30	2	30
M12x1.25	8090020416	12	32	30	2	30
M12x1.5	8090020420	10	32	30	2	30
M12x1.75	8090020421	10	32	30	2	30
M12x1.75	8090020486	17	32	30	2	30
M12x1.75	8090020479	25	32	30	2	30
M14x1.25	8090020422	10	32	30	2	30
M14x1.25	8090020417	12	32	30	2	30
M14x1.5	8090020423	10	32	30	2	30
M14x1.5	8090020478	10	32	30	2	22
M14x1.5	8090020487	12	32	30	2	30
M14x1.5	8090020477	20	32	30	2	30
M16x1.25	8090020425	10	32	30	2	30
M16x1.5	8090020426	10	32	30	2	30
M16x1.5	8090020415	14	32	30	2	30
M18x1.5	8090020428	10	32	30	2	30
M18x1.5	8090020476	12	32	30	2	30
M18x1.5	8090020469	14	32	30	2	30
M18x1.5	8090020084	19	32	30	2	30
M20x1.5	8090020430	10	32	30	2	30
M20x1.5	8090020480	14	32	30	2	30
M20x1.5	8090020432	15	32	30	2	30
M22x1.5	8090020435	7	32	30	2	30
M22x1.5	8090020437	14	32	30	2	30
M22x1.5 47L	8090020438	10	32	30	2	30
M22x1.5 42L	8090020439	10	32	30	2	30
M22x1.5	8090020436	10	32	30	2	30
M22x1.75	8090020441	10	32	30	2	30
M24x1.5	8090020443	10	32	30	2	30
M24x1.5	8090020444	12	32	30	2	30
M24x1.5	8090020445	15	27	30	2	30
M24x1.5 47L	8090020448	10	27	30	2	30
M24x2.0	8090020447	12	32	30	2	30

M24x2.0	8090020488	21	32	30	2	30
M25x1.5	8090020483	13	32	30	2	32
M25x1.5	8090020451	15	27	30	2	32
M26x1.5	8090020452	10	32	30	2	32
M26x1.5 50L	8090020455	10	45	30	2	32
M26x1.5 47L	8090020454	17	32	30	2	32
M26x1.5	8090020484	16	32	30	2	32
M27x1.5	8090020456	10	32	30	2	32
M27x1.5	8090020457	12	32	30	2	32
M27x2.0	8090020458	12	32	30	2	32
M27x2.0	8090020459	12	32	30	O-ring	32
M30x1.5	8090020463	10	32	30	2	36
M32x1.5	8090020467	12	32	30	2	30
M32x1.5	8090020472	20	32	30	2	30
M36x2.0	8090020471	12	32	30	2	42
M42x2.0	8090020469	12	32	30	2	50

BSP

Thread size (D)		T	A	B	S	Hex
3/8"-19-BSP	8080020501	10	32	30	2	30
1/2"-14-BSP	8080020502	10	32	30	2	30
3/4"-14-BSP	8080020504	10	32	30	2	32
3/4"-14-BSP	8080020505	12	32	30	2	32
3/4"-14-BSPT	8080020511	15	32	30	2	32
1"-11-BSP	8080020506	12	32	30	2	36

For all sizes not mentioned,
 please contact us for a free quote

CLICK DRAIN LB
PRODUCT SPECIFICATIONS

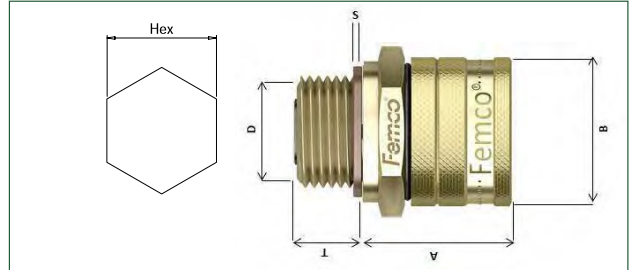

NPT						
Thread size (D)		T	A	B	S	Hex
1/4"-18-NPT	8060020511	10	32	30	2	30
3/8"-18-NPT	8060020512	10	32	30	2	30
1/2"-14-NPT	8060020513	12	32	30	2	30
1/2"-14-NPT	8060020521	24	32	30	2	30
3/4"-14-NPT	8060020514	12	32	30	2	32
3/4"-14-NPT	8060020520	15	32	30	2	32
1"-11.5-NPT	8060020516	12	32	30	2	36

UNS						
Thread size (D)		T	A	B	S	Hex
1"-18-UNS	8060020519	12	32	30	2	32

UNF						
Thread size (D)		T	A	B	S	Hex
1/2"-20-UNF	8080020477	10	32	30	2	30
1/2"-20-UNF	8080020512	12	32	30	2	30
1/2"-20-UNF	8080020476	20	32	30	2	30
1/2"-20-UNF	8080020475	30	32	30	2	30
9/16"-18-UNF	8080020478	10	32	30	2	30
5/8-18-UNF	8080020485	12	32	30	2	30
3/4"-16-UNF	8080020481	10	32	30	2	30
3/4"-16-UNF	8080020482	15	32	30	2	30
3/4"-16-UNF	8080020417	22	32	30	2	30
7/8"-14-UNF	8080020483	10	32	30	2	30
7/8"-18-UNF	8080020486	10	32	30	2	30
7/8"-20-UNF	8080020487	10	32	30	2	30
1-12-UNF	8080020488	12	30	30	2	32
1"-14-UNF	8080020489	12	30	30	2	32
1"-18-UNF	8080020524	22	32	30	2	32
1 1/16-12-UNF	8080020493	10	32	30	2	32
1 1/16"-12-UNF	8080020490	15	32	30	2	32
1 1/4"-12-UNF	8080020492	12	30	30	2	36
1 5/16"-12-UNF	8080020493	12	32	30	2	32
1 5/16"-12-UNF	8080020494	12	32	30	2	32
1 1/8"-12-UNF	8080020491	15	27	30	2	36
1 1/2"-12-UNF	8080020496	12	32	30	2	46
1 1/2-12-UNF	8080020497	17	32	30	2	46
1 5/8-12-UNF	8080020500	15	32	30	2	46

For all sizes not mentioned, please contact us for a free quote

**CLICKERS LB
ACCESSORIES**

**CLICKERS SB
ACCESSORIES**

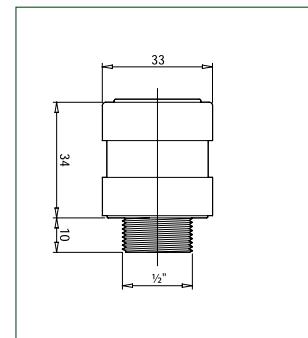
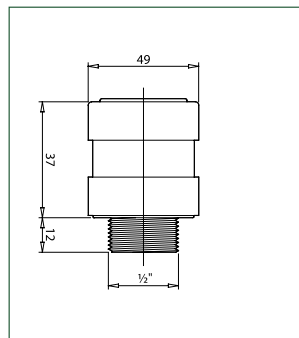
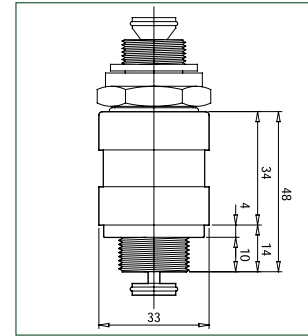
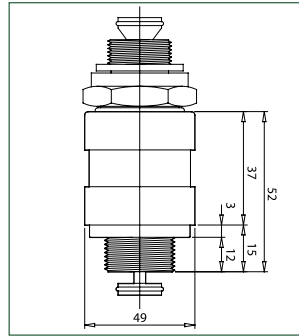

Solo Clicker		
Description		Connection
Solo Clicker	851000	1/2 BSP
Solo Clicker	851014	1" BSP
Solo Clicker hose connection	851015	

Double Clicker		
Description		Connection
Double Clicker	8510013	3/4 BSP
Double Clicker	851017	1/2 BSP
Double Clicker	851018	3/4-14-BSP
Double Clicker	851019	1" BSP

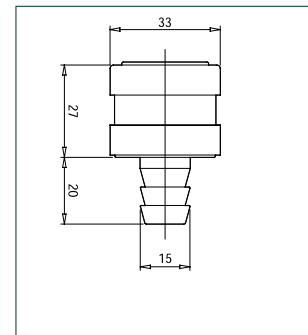

Solo Clicker		
Description		Connection
Solo Clicker hose connection	850101	
Solo Clicker hose connection	850105	
Solo Clicker hose connection	850106	
Solo Clicker	850102	1/2 BSP

Double Clicker		
Description		Connection
Double Clicker	850104	1/2 BSP

For all sizes not mentioned, please contact us for a free quote

Straight Drainers

Description		Connection	Hose (mm)
Straight Drainer	851001	1/2-BSP	
Straight Drainer with hose	851002	1/2-BSP	250
Straight Drainer with hose	851003	1/2-BSP	1300

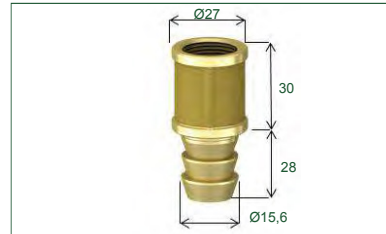

Angled Drainers 90°

Description		Connection	Hose (mm)
Angled Drainers 90°	851004	1/2-BSP	
Angled Drainers 90° with hose	851005	1/2-BSP	250
Angled Drainers 90° with hose	851006	1/2-BSP	1300

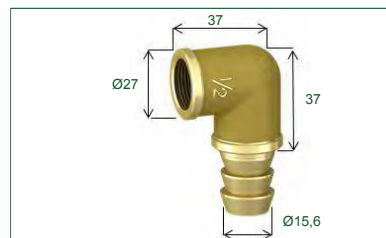

Angled Drainers 45°

Description		Connection	Hose (mm)
Angled Drainers 45°	851007	1/2-BSP	
Angled Drainers 45° with hose	851008	1/2-BSP	250
Angled Drainers 45° with hose	851009	1/2-BSP	1300



Sampling nipple

Description	
Sampling nipple	951007

Dust Caps

Description		Connection
Dust cap	851010	M26x1.5
Dust cap + Chain	851011	M26x1.5

Hose

Description		Size	(mm)
Clamp	951005	3/4"	
Hose	101095	18x23 - 3/4"	250
Hose	101097	18x23 - 3/4"	1300

For all sizes not mentioned,
please contact us for a free quote

XL oil drain plug

The XL oil drain plug is specially designed to change large volumes of oil in a short time. The flow rate of the XL Drain is optimised, and is increased by 48% which allows large amounts of oil to be drained quickly. The XL oil drain plug is the ideal solution for vehicles and machines with large oil storage such as trucks and mining equipment.



Application: Engine oil, Hydraulic oil, Gearbox oil, Coolant, Lubricating oil

Material: Brass outside / Brass inside / Stainless steel spring

Temperature range: -20° / 200° Celsius

Valve: Brass with Viton O-ring / Valve

Dust cap: Brass, Thread size M36x1,5

Dust cap seal: NBR O-ring

Body seal: Viton O-ring

HOW TO DRAIN YOUR OIL (OR OTHER FLUIDS)

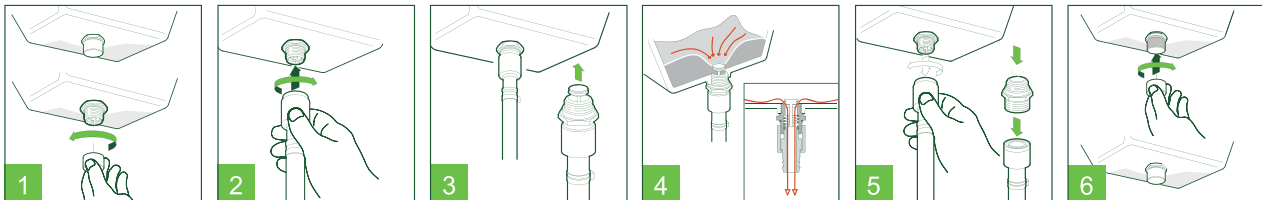

XL DRAIN
PRODUCT SPECIFICATIONS

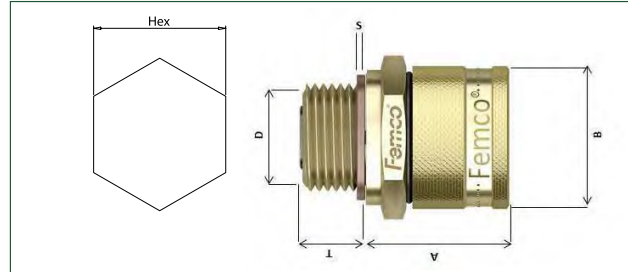

Metric. Sizes

Thread size (D)		T	A	B	S	Hex
M27x2.0	5090020272	12	30	40	2	36
M30x1,5	5090020301	10	32	40	2	36
M32x1,5	5090020321	12	30	40	2	41
M32x2,0	5090020322	12	30	40	2	41
M36x1,5	5090020361	12	30	40	2	42
M36x1,5	5090020362	20	30	40	2	42
M38x1,5	5090020381	12	30	40	2	46

NPT

Thread size (D)		T	A	B	S	Hex
1"-11.5-NPT	5060021115	12	30	40		41
1-11.5-NPT	5060021116	17	30	40		41

UNF

Thread size (D)		T	A	B	S	Hex
1 1/8"-12-UNF	5080021180	15	27	40	2	36
1 5/16-12 UNF	5080021516	12	30	40	2	36
1 1/2"-12-UNF	5080021120	12	30	40	2	46
1 1/2"-12UNF	5080021122	17	30	40	2	36
1 5/8-12	5080021580	15	30	40	2	36
2"-12 UNF	5080022000	12	30	40	2	60

BSP

Thread size (D)		T	A	B	S	Hex
1"-11-BSPT	5070021110	25	29	40	2	41
1"-11-BSP	5070021111	12	30	40	2	41
1 1/4-BSP	5070021113	12	30	40	2	41
1 1/2-BSP	5070021114	12	30	40	2	41
1 1/2-11-BSP	5070021112	20	30	40	2	41
2-BSP	5070021115	12	30	40	2	41

Straight Drainers

Description		Connection	Hose (mm)
Straight Drainer	655001	M36x1.5	
Straight Drainer with hose	655002	M36x1.5	250
Straight Drainer with hose	655003	M36x1.5	1300

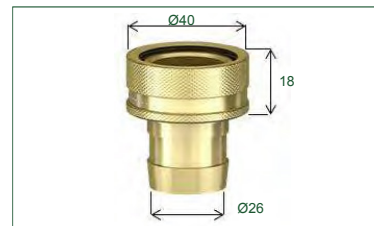

Angled Drainers 90°

Description		Connection	Hose (mm)
Angled Drainers 90°	655009	M36x1.5	
Angled Drainers 90° with hose	655010	M36x1.5	250
Angled Drainers 90° with hose	655011	M36x1.5	1300

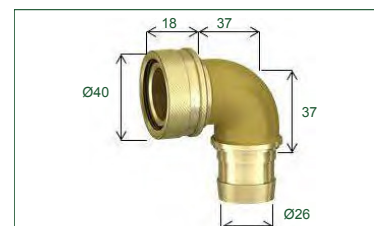

For all sizes not mentioned, please contact us for a free quote