

Threading

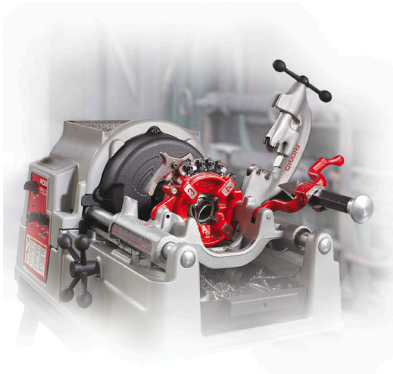

Threading



- Dependable heavy duty machines for maximum up-time, superior quality threads and minimal threading time.
- Industry's widest selection of hand and power threading equipment.
- Manual "hammer" type chuck and "auto-chuck" models.



Type	No. of Models	Pipe Capacity*		Page
		in	mm	
Manual Ratchet Threaders				
Exposed Ratchet Threader Sets	6	1/8 - 2	6 - 50	4.3
Enclosed Ratchet Threader Sets	5	3/8 - 2	10 - 50	4.3
Ratchet and Handle Only	5	—	—	4.4
Three-way Pipe Threaders	3	1/2 - 1	12 - 25	4.4
Carrying Case	1	—	—	4.4
Hand Threader Die Heads	—	1/8 - 2	6 - 50	4.5
Manual Threader Pipe Dies	—	1/8 - 2	6 - 50	4.7
Manual Receding Threaders				
Manual Receding Threaders	4	1 - 2	12 - 50	4.8
Pipe Dies for Geared Receding Threaders	—	2 1/2 - 6	65 - 150	4.8
Power Threading w/ Geared Threaders	—	—	—	4.9
Receding Geared Threaders	3	2 1/2 - 6	65 - 150	4.10
Geared Threader Accessories	—	—	—	4.10
Pipe Dies	—	—	—	4.11
Accessories				
Cutting Oil	9	—	—	4.12
Oiler	4	—	—	4.12
Power Drives				
Model 600	6	1/8 - 1 1/4	6 - 32	4.13
Model 690	6	1/8 - 2	6 - 50	4.14
Model 700	4	1/8 - 2	6 - 50	4.15
Model 300	4	1/8 - 2	6 - 50	4.16
Threading Machines				
Model 300 Complete	4	1/8 - 2	6 - 50	4.17
Model 535A Threading Machine	8	1/8 - 2	6 - 50	4.18
Model 535 Threading Machine	8	1/8 - 2	6 - 50	4.20
Model 300 Compact Threading Machine	3	1/8 - 2	6 - 50	4.22
Machine Threader Stands	4	—	—	4.24
Optional Die Heads	11	1/8 - 2	6 - 50	4.25
Model 1233 Threading Machine	3	1/4 - 3	8 - 80	4.26
Die Heads for 1233	9	2 1/2 - 3	65 - 80	4.27
Model 1224 Threading Machine	3	1/4 - 4	8 - 100	4.28
Die Heads for 1224	7	1/4 - 4	8 - 100	4.29
Pipe Dies for Machine Die Heads	—	1/8 - 2	6 - 50	4.30
Nipple Chucks/Adapters	—	—	—	4.33

* Pipe capacity = maximum nominal diameter of steel pipe

Threader Selection

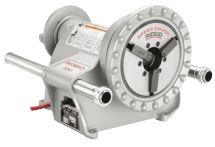
Pipe Threads (inches)				Bolt Threads				Model	Page No.
NPT	BSPT	NPSM	BSPP	ISO/Metric	UNC/UNF	ACME			
–	–	–	–	–	¼ - 1	–	 Manual Ratchet Threaders	00-RB	4.4
½ - 2	½ - 2	½ - 1¼	¾ - 1¼	20 - 40*	–	–		11-R	4.3
½ - 2	½ - 2	½ - 2	¼ - 2	–	–	–		12-R	4.3
½ - 1	½ - 1	½ - 1	½ - 1	–	–	–		31-A Series**	4.4
1 - 2	1 - 2	–	–	–	–	–	 Receding Threaders	65-R	4.8
2½ - 4	2½ - 4	–	–	–	–	–		141	4.10
4 - 6	4 - 6	–	–	–	–	–		161	4.10
½ - 1¼	½ - 1¼	½ - 1¼	¾ - 1	20 - 40*	–	–	 Power Drives	600	4.13
½ - 2	½ - 2	½ - 2	¼ - 2	20 - 40*	–	–		690	4.14
½ - 2	½ - 2	½ - 2	¼ - 2	–	¼ - 1	–		700	4.15
½ - 2	½ - 2	½ - 2	¼ - 2	–	¼ - 2	¾ - 1½		300	4.16
½ - 2	½ - 2	½ - 2	¼ - 2	6 - 52	¼ - 2	¾ - 1½	 Threading Machines	300 Complete	4.17
½ - 2	½ - 2	½ - 2	¼ - 2	8 - 52	⅝ - 2	⅝ - 2		535-A	4.18
½ - 2	½ - 2	½ - 2	¼ - 2	6 - 52	¼ - 2	¾ - 1½		535	4.20
½ - 2	½ - 2	½ - 2	¼ - 2	6 - 52	¼ - 2	¾ - 1½		300 Compact	4.22
½ - 3	½ - 3	½ - 3	½ - 3	6 - 52	¼ - 2	¾ - 1½		1233	4.26
¼ - 4	¼ - 4	½ - 2	¼ - 2	6 - 52	¼ - 2	¾ - 1½		1224	4.28

* ISO conduit

** Standard configuration but can use any 12-R dies.

Manual Ratchet Threaders

All matched Threader/Sets include Die Heads, Ratchet Assembly, Ratchet Handle and Alloy Dies. All Threader Sets use same 12-R Dies in Die Head.



Catalog No.			Model No.	Capacity in.	Weight	
NPT	BSPT	NPSM			lb.	kg
36480	—	—	12-R	½ - 1¼	23¾	10,8
36475	65255	36510	12-R	½ - 2	34¾	15,8
36505	65285	—	12-R	½ - 2	45½	20,7

Exposed Ratchet Threader Sets

- Model 12-R: Capacity ½" - 2" with carrying case.



Enclosed Ratchet Threader Sets

- Model 11-R capacity: ½" - 2"

Catalog No.	Model No.	Description	Dies	Weight	
				lb.	kg
13073	11-R	¾ - 1¼" RH Threader & Plastic Case	BSPT	24¾	11
13078	11-R	¾ - 2" RH Threader & Plastic Case	BSPT	33	15
13083	11-R	½ - 1¼" RH Threader & Plastic Case	BSPT	22	10
13088	11-R	½ - 2" RH Threader & Plastic Case	BSPT	31¼	14,2
13093	11-R	¾ - 2" LH-RH Threader & Plastic Case	BSPT	61½	28

Manual Ratchet Threaders



Ratchet & Handle Only

Ratchet knob indicates forward and reverse. Die heads snap in from both sides and lock in place.

Catalog No.	Model No.	Description
38540	00-RB	Ratchet & Handle Only
38540	00-R	
37777	11-R	
38550	111-R	
30118	12-R	



Three-Way Pipe Threaders

Each model cuts three thread sizes and uses 12-R ratchet threader dies.

Model No.	RH Alloy	RH High Speed	RH High Speed for Stainless Steel	Capacity in.	Weight	
					lb.	kg
31-A NPT	36540	36550	36555	1/2, 3/4, 1	10	4,6
31-A BSPT	65320	–	–	1/2, 3/4, 1	10	4,6
31-A NPSM	36560	–	–	1/2, 3/4, 1	10	4,6



Carrying Case

- Helps keep die sets organized.

Catalog No.	Description	Thread Type	Length x Width x Height (in.)	Weight	
				lb.	kg
21218	Plastic Case (does not contain die heads)	12-R 11-R	25 x 5 x 14	6	2,5

Die Heads

Manual Threaders – Models 00-R, 12-R, 11-R & 00-RB



North American Standards

	Catalog No.									
	Nominal Pipe Size (in.)									
	1/8	1/4	3/8	1/2	3/4	1	1 1/4	1 1/2	2	
Model No. 00-R										
(NPT)										
Alloy RH	36875	36880	36885	36890	36895	36900	–	–	–	
High-Speed RH	36935	36940	36945	36950	36955	36960	–	–	–	
High-Speed for Stainless Steel RH	36965	36970	36975	36980	36985	36990	–	–	–	
(NPSM)										
Alloy RH	36995	37000	37005	37010	37015	37020	–	–	–	
API High-Speed	–	–	83435	68775	68780	–	–	–	–	
Model No. 12-R										
(NPT)										
Alloy RH	37375	37380	37385	37390	37395	37400	37405	37410	37415	
High-Speed LH	–	–	–	37435	37440	37445	37450	37455	37460	
High-Speed RH	37465	37470	37475	37480	37485	37490	37495	37500	37505	
High-Speed for Stainless Steel RH	37510	37515	37520	37525	37530	37535	37540	37545	37550	
High-Speed for PVC RH	–	83450	83455	83460	83465	83470	83475	83480	83485	
High-Speed for Plastic Coated Pipe	–	–	–	51857	51862	51867	51872	51877	51882	
Alloy for IMC RH	–	–	–	92690	92695	92700	92705	92710	92715	
(NPSM)										
Alloy RH	37555	37560	37565	37570	37575	37580	37585	37590	37595	
Model No. 11-R										
(NPT)										
Alloy RH	37025	37030	37035	37040	37045	37050	37055	20923	20943	
High-Speed RH	37095	37100	37105	37110	37115	37120	37125	20928	20948	
High-Speed for Stainless Steel RH	37130	37135	37140	37145	37150	37155	37160	20933	20953	
(NPSM)										
Alloy RH	37165	37170	37175	37180	37185	37190	37195	20938	20958	
	1/4	5/16	3/8	7/16	1/2	9/16	5/8	3/4	7/8	1
Model No. 00-RB										
(UNC)										
Alloy RH	37610	37615	37620	37625	37630	37635	37640	37645	37650	37655
Alloy LH	–	–	–	37675	–	–	–	37695	–	–
(UNF)										
Alloy RH	37710	37715	37720	37725	37730	37735	37740	37745	–	37755
Alloy LH	–	–	–	37775	37780	37785	37790	37795	37800	37805

Unless highlighted, all die heads come complete with selected dies and are set at the factory.
 ■ Highlighted die heads require assembly with supplied dies.
 All matched threader/sets include die heads, ratchet assembly, ratchet handle and specified dies.

Die Heads

Ratchet Threaders – Models 00-R, 12-R, 11-R



British & International Standards

	Catalog No.								
	Nominal Pipe Size (in.)								
	1/8	1/4	3/8	1/2	3/4	1	1 1/4	1 1/2	2
Model No. 00-R									
(BSPT)									
Alloy RH	65705	65710	65715	65720	65725	65730	–	–	–
High-Speed RH	65765	65770	65775	65780	65785	65790	–	–	–
Model No. 12-R									
(BSPT)									
Alloy RH	65950	65955	65960	65965	65970	65975	65980	65985	65990
High-Speed RH	–	–	–	66040	66045	66050	66055	66060	66065
Plastic Coated (BSPP)	–	–	–	83677	83682	83687	83692	83697	83702
Alloy RH	–	49932	49937	49942	49947	49952	–	49962	49967
Model No. 11-R									
(BSPT)									
Alloy RH	65550	65555	65560	65565	65570	65575	65580	12553	12558
High-Speed RH	–	–	65620	65625	65630	65635	65640	–	–
High-Speed LH	13028	13033	13038	13043	13048	13053	13058	13063	13068
(BSPP)									
Alloy RH	–	–	65680	65685	65690	65695	65700	–	–

British & International Standards

	Catalog No.			
	Nominal Pipe Size (mm)			
	20 mm	25 mm	32 mm	40 mm
Model No. 11-R				
(ISO) Alloy RH	75005	75010	75015	75020

All Die Heads complete come with selected dies and are set at the factory.
 ■ Highlighted die heads require assembly with supplied dies.
 All matched Threader/Sets include Die Heads, Ratchet Assembly, Ratchet Handle and Specified Dies.

Pipe Dies

Models 00-R, 11-R, 12-R, O-R, Ratchet Threaders or 30A, 31A 3-Way Pipe Threaders



Die Material or Type	Catalog No.								
	Nominal Pipe Size – Threads Per Inch								
	1/8 - 27	1/4 - 18	3/8 - 18	1/2 - 14	3/4 - 14	1 - 11½	1¼ - 11½	1½ - 11½	2 - 11½
(NPT) National Pipe Taper									
Alloy RH	37810	37815	37820	37825	37830	37835	37840	37845	37850
High-Speed RH	37855	37860	37865	37870	37875	37880	37885	37890	37895
High-Speed LH	–	38050	38055	38060	38065	38070	38075	38080	38085
H.S. For Stainless Steel RH	37900	37905	37910	37915	37920	37925	37930	37935	37940
H.S. For PVC RH	–	–	70685	70690	70695	70700	70705	70710	70715
HS Reversible RH*	–	–	–	49707	49712	49717	49722	49727	–
(NPSM) National Pipe Straight Mechanical									
Alloy RH	37945	37950	37955	37960	37965	37970	37975	37980	37985
(BSPT) British Standard Pipe Taper**									
	1/8 - 28	1/4 - 19	3/8 - 19	1/2 - 14	3/4 - 14	1 - 11	1¼ - 11	1½ - 11	2 - 11
Alloy RH	66110	66115	66120	66125	66130	66135	66140	66145	66150
High-Speed RH	66310	66315	66320	66325	66330	66335	66340	66345	66350
High-Speed LH	66405	66410	66415	66420	66425	66430	66435	–	66445
* HS Reversible RH	–	–	56337	56342	56347	56352	–	–	56367
High Speed for Plastic Coated	–	–	–	92482	92477	92487	92492	92497	92542

* Dies can be reversed in die head for close to wall threading.

** Requires British Die Head.

ISO International Standards Organization	Nominal Conduit Size in mm – Thread Pitch in mm			
	20 - 1,5	25 - 1,52	32 - 1,5	40 - 1,5
Alloy RH	85830	76305	85835	76315

Requires 11-R ISO Die Head, see page 4.6

BEC British Electrical Conduit (1)	Nominal Conduit Size – Threads Per Inch					
	1/2 - 18	5/8 - 8	3/4 - 16	1 - 16	1¼ - 16	1½ - 14
Alloy RH	66155	66160	66165	66170	66175	–

Requires 11-R BEC Die Head

Manual Receding Threaders

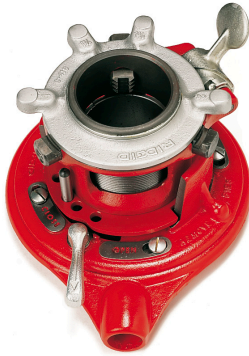

Model 65R-TC

- Threads 1" - 2" pipe.
- True centering workholder.
- Jam-proof.
- Right-hand only.

Catalog No.	Model No.	Description	Capacity Nominal Pipe Size		Weight	
			in.	lb.	kg	
36570	65R-TC	NPT with 1 Set High-Speed Dies	1 - 2	27	12,3	
65345	65R-TC	BSPT with 1 Set High-Speed Dies	1 - 2	27	12,3	
96720	–	Metal Carrying Case for 65R Series Threaders	–	8	3,7	



Model 65R-C

- Threads 1" - 2" pipe.
- Jam-proof drive pawl.
- Cam workholder sets instantly.
- Right-hand only.

Catalog No.	Model No.	Description	Capacity Nominal Pipe Size		Weight	
			in.	lb.	kg	
36565	65R-C	NPT with 1 Set High-Speed Dies	1 - 2	25	11,4	
65340	65R-C	BSPT with 1 Set High-Speed Dies	1 - 2	25	11,4	
96720	–	Metal Carrying Case for 65R Series Threaders	–	8	3,7	

Receding Threaders Pipe Dies for Models 65R-C & 65R-TC Ratchet Threaders

Die Material or Type	Catalog No.	
	(NPT) National Pipe Taper	(BSPT) British Std. Pipe Taper
	1" Thru 2" - 11½ TPI	1" Thru 2" - 11 TPI
High-Speed RH	38100	66450*
H.S. For Stainless Steel RH	38105	–
H.S. For Cast Iron RH	38110	–

* Requires BSPT Threader

Pipe Dies for Model 4PJ Geared Pipe Threaders

Die Material or Type	Catalog No.							
	(NPT) National Pipe Taper Nominal Pipe Size - Threads Per Inch				(NPSM) National Pipe* Nominal Pipe Size - Threads Per Inch			
	2½ - 8	3 - 8	3½ - 8	4 - 8	2½ - 8	3 - 8	3½ - 8	4 - 8
High-Speed RH	38220	38225	38230	38235	46732	46737	46742	46747
H.S. For Cast Iron RH	38240	38245	38250	38255	–	–	–	–

* Requires NPSM Threader

Die Material or Type	Catalog No.			
	(BSPT) British Standard Pipe Taper Nominal Pipe Size - Threads Per Inch			
	2½ - 11	3 - 11	3½ - 11	4 - 11
High-Speed RH	66535*	66540*	–	66550*

* Requires BSPT Threader

Geared Threader Configurations

Power Threading with Model 141 and 161 Geared Threaders

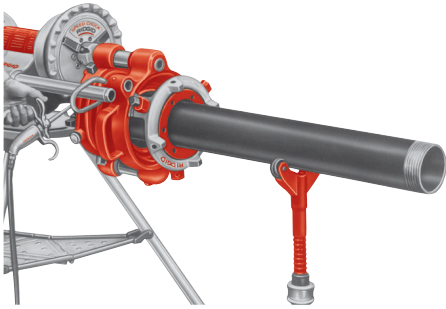

300 Front-Mount



535 Rear-Mount

300 Power Drive Front-Mount

Application for 141 and 161 Geared Threader requires:

- 1206 Stand (pg. 4.17)
- Pipe Support (pg. 2.5)
- 418 Oiler (pg. 4.12)
- 844 Drive Bar (pg. 4.10)
- 758 Loop – for 141 (pg. 4.10)
- 346 Support Arms – for 161 (pg. 4.10)

300 Power Drive Rear-Mount

Application for 141 and 161 Geared Threader requires:

- 1206 Stand (pg. 4.17)
- 460 TRISTAND (pg. 2.2)
- 418 Oiler (pg. 4.12)
- 840A Universal Drive Shaft (pg. 4.10)

535 Threading Machine Front-Mount

(pg. 4.21)

535 Threading Machine Rear-Mount (manual chuck only)

Application for 141 and 161 Geared Threader requires:

- 460 TRISTAND (pg. 2.2)
- 418 Oiler (pg. 4.12)
- 840A Universal Drive Shaft (pg. 4.10)

300 Compact Threading Machine Front-Mount

Application for 141 Geared Threader requires:

- 343 Kit (pg. 4.10)

1233 Threading Machine Front-Mount

Application for 141 Geared Threader requires:

- 343 Kit (pg. 4.10)

1224 Threading Machine Rear-Mount

Application for 161 Geared Threader requires:

- 840A Universal Drive Shaft (pg.4.10)
- 460 TRISTAND (pg. 2.2)
- 418 Oiler (pg. 4.12)

Receding Geared Threaders

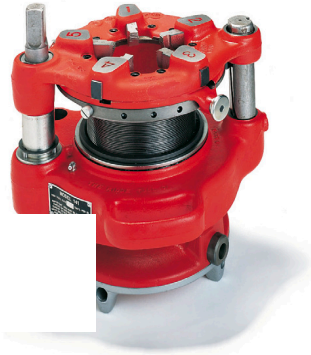

Models 141/161

- Model 141 threads 2½", 3", 3½", 4" pipe with one set of dies.
- Model 161 threads 4", 4½", 5", 6" pipe with one set of dies. (NPT only)
- Jaw clutch prevents jamming.
- Simple adjustment for tapered or straight threads.
- Cam-type workholder sets instantly.
- Fully enclosed gearing.
- Right-hand only.

Catalog No.	Model No.	Description	Capacity Nominal Pipe Size	Weight	
			in.	lb.	kg
36620	141	NPT with 1 Set High-Speed Dies	2½ - 4	88	40
65380	141	BSPT with 1 Set High-Speed Dies	2½ - 4	88	40
36630	161	NPT with 1 Set High-Speed Dies	4 - 6	141	64
39380	D-1440	Ratchet and Handle	—	9½	4,3
96725	—	Metal Carrying Case for 141 Geared Threaders	—	17	7,7
41620	—	Gearhead Motor Grease	—	1	0,5

Geared Threader Accessories



Model 840A Universal Drive Shaft

A telescoping (104 - 127 cm) drive shaft for operation of Nos. 141 and 161 geared threaders with threading machines.

Geared Threader Operation

The Nos. 141 and 161 geared threaders, in conjunction with these accessories, allow power drives and threading machines to thread up to 4" and 6" pipe. See page 4.9



Model 46 Pipe Support



Model 346 Support Arms



No. 758 Loop



Model 844 Drive Bar

Catalog No.	Model No.	Description	Weight	
			lb.	kg
42505	46	Adjustable Pipe Support (page 2.5)	23	10,4
61122	840A	Universal Drive Shaft	26	11,8
19366	758	Loop (141 with 300 Power Drive)	1¼	0,6
40005	346	Support Arms (161 with 300 Power Drive)	10½	4,8
42405	844	Drive Bar (300, 535M & old style)	5¾	2,6
42415	768	Drive Link Assembly (535, 535M & old style)	2½	1,1
54587	343	Kit 343 on 300 Compact and 1233 Threading Machine (drive bar included)	9	4,1
97882*	—	Kit 141 on 535 Auto Chuck with High-Clearance Carriage	12	5,4
16723**	—	Kit 141 on 535 Manual Chuck with High-Clearance Carriage	12	5,4

* Kits include all accessories necessary for threading with a 141 mounted on a 535 with a high-clearance carriage.

** Drive bar 844 not included.

Pipe Dies

Model 141 Geared Pipe Threaders

Die Material or Type	Catalog No.		
	(NPT) National Pipe Taper	(BSPT) British Std. Pipe Taper	Beveling Dies
	2½" Thru 4" - 8 TPI	2½" Thru 4" - 11 TPI	2½" Thru 4"
High-Speed RH	38120	66625*	—
H.S. For Stainless Steel RH	70640	70645*	—
H.S. For Cast Iron RH	38125	—	—
H.S. For PVC RH	38130	—	—
H.S. 37½° Bevel	—	—	38140

(NPSM) National Pipe Straight Mechanical – Use (NPT) Dies and Rotate Threader Guide Post 180°

(BSPP) British Standard Pipe Parallel – Use (BSPT) Dies and Rotate Threader Guide Post 180°

** Requires BSPT Threader*

Model 161 Geared Pipe Threaders

Die Material or Type	Catalog No.	
	(NPT) National Pipe Taper	(BSPT) British Std. Pipe Taper
	4" Thru 6" - 8 TPI	4" Thru 6" - 11 TPI
High-Speed RH	38155	66620*
H.S. For Stainless Steel RH	70655	—

(NPSM) National Pipe Straight Mechanical – Use (NPT) Dies and Rotate Threader Guide Post 180°

(BSPP) British Standard Pipe Parallel – Use (BSPT) Dies and Rotate Threader Guide Post 180°

** Requires BSPT Threader*

Cutting Oil



Thread Cutting Oil

- Cools threads and pipe during operation.
- Speeds metal removal.
- Improves thread quality.
- Reduces threading torque.

RIDGID thread cutting oils are free of chlorine and other halogens, PCBs and heavy metals. Complete material safety data sheet available.

Catalog No.	Container Size	Weight		Std. Pack
		lb.	kg	
11931	5 Litres	51	23,2	4
11531	25 Litres	51½	23,5	1
18251	240 Litres (48 x 5 L)	573	260	48
16681	480 Litres (96 x 5 L)	1,228	557	96
15681	600 ml Spray	9¼	4,2	12
11091	5 Litres Synthetic	51	23,2	4
11441	5 Litres Synthetic (Denmark only)	51	23,2	4
19611	500 ml Synthetic Spray	14	6,4	12
41620	500.0 gram Gearhead Motor Grease	—	—	1

Oiler



Model 418 Oiler

The Model 418 hand-held oiler is sturdier than ever before. The 418's pump assembly and heavy-duty reservoir are designed to increase productivity.

Pump Assembly

- 50% more oil per stroke than other hand-held oilers for longer die life.
- An ergonomic two-finger trigger design that reduces user fatigue.
- Die cast, heavy-duty body with swivel nozzle with no exposed parts for longer life.

Heavy Duty Reservoir

- The Model 418 oiler features a patent pending fastenerless twist and lock drip pan that easily locks in place.
- The material withstands abrasion, is lighter than metal and does not rust.
- The reservoir will not crack or leak.
- Material is so strong that under normal use, no dents will form on impact or shape changes will occur over time. As a result, the drip pan will fit squarely on the reservoir time after time.
- Integral molded body eliminates leaks at the hose-reservoir connection.
- Convenient anti-slip grip design with integral hook for easy hanging.
- Dimensions: Chip pan diameter 362 mm; Depth 212 mm; Hose length 1,4 m.

Catalog No.	Model No.	Description	Weight	
			lb.	kg
73442	418	Oiler with 5 Litres of Thread Cutting Oil	20½	9,4
72342	402	Utility Oiler (Consists of Pump, Hose, and Attachments to screw onto 1-Gallon Oil Can. Oil Can and Oil not included)	2½	1,2
72332	#4	Hand-operated oiler only	1¼	0,5
72327	#4	Hand-operated oiler with 54" hose and hose fittings	2¼	1,0

Hand-Held Power Drives



Model 600 Power Drive

- A hand-held, powerful, portable power drive.
- Features a reversible 115 V or 230 V universal motor.
- Capacity 1/8 - 1 1/4" (6 - 32 mm) pipe. Designed for RIDGID 11-R die heads.
- Ideal for on-site applications such as gas line pipe installation.

Technical Specifications

- Motor: Universal 1.020 Watt, 230 or 115 V, 50/60 Hz.
- Switch: Heavy-duty paddle-type switch with safety lock off switch. Separate FORWARD/ REVERSE switch.
- Gear Housing: Die Cast Aluminium.
- Gear Head: Spur and worm gear reduction drive.
- Body & Handle: Durable heavy-duty fiberglass reinforced plastic.
- Spindle Speed: 32 RPM (No load).
- Capacity: 1/8 - 1 1/4" (6 - 32 mm) pipe.
- Die Heads Included: 1/2, 3/4, 1, 1 1/4 (Type 11-R).
- Includes Model 601 support arm.
- Weight: 12 1/2 lbs. (5 1/2 kg) power drive only.
- Length: 20 in. (51 cm).



Model 601 Support Arm
(Standard Equipment)

Catalog No.	Model No.	Description	Dies	Weight	
				lb.	kg
13621	600	230 V Machine Only	—	12 1/8	5,5
13631	600	115 V Machine Only	—	12 1/8	5,5
14151	600	230 V Machine Only (Switzerland Only)	—	12 1/8	5,5
13571	600-C	230 V 1/2 - 1 1/4" with Support Arm and Carrying Case	BSPT	32	14,5
14171	600-C	230 V 1/2 - 1 1/4" with Support Arm and Carrying Case (Switzerland Only)	BSPT	32	14,5
13661	600-C	115 V 1/2 - 1 1/4" with Support Arm and Carrying Case	BSPT	32	14,5
Accessories					
73442	418	Oiler with 5 litres of Thread Cutting Fluid		20 1/2	9,4
34497	601	Support Arm		3	1,36
13793	—	Metal Carrying Case		—	—



Model 690 Power Drive

The model 690 Power Drive is a lightweight and powerful hand-held power drive. It is designed for threading 1/4" - 2" (6 - 50 mm) pipe with the use of 11-R Die Heads. The model 690 is equipped with a full set of 11-R Die Heads, 1/2" - 2", the 691 Support Arm and a durable Carrying Case. The model 690 Power Drive is the perfect lightweight and portable power drive for maintenance and repair workers, as well as service plumbers requiring 2" pipe capacity.



Model 690 with Support Arm, Die Heads and Carrying Case

- Capacity: 1/8" - 2" (6 - 50 mm) pipe.
- Weight: 19 lbs. (8,6 kg), Power Drive only.
- Length: 24 in. (61 cm).
- Motor: Universal 1.020 Watt, 230 or 115 V, 50/60 Hz.
- Switch: Heavy-duty paddle switch with safety lock-off device (automatically locks off when released). Separate FORWARD/RELEASE switch.
- Gear Head: Spur gear reduction/face gear drive. All shafts, ball and needle bearing mounted. Permanently lubricated gear housing.
- Gear Housing: Die cast aluminium.
- Body & Handle: Durable, heavy-duty, fiberglass-reinforced, industrial plastic.
- Spindle Speed: 32 RPM (No load).
- Die Heads included: 1/2", 3/4", 1", 1 1/4", 1 1/2", 2" (type 11-R).
- Includes Support Arm: Model 691.
- Die Head Adapter: Used with 1/8" through 1 1/4" die heads.
- Carrying Case.
- Weight: 8,5 kg (machine only).



Model 690 with Support Arm

Catalog No.	Model No.	Description	Dies	Weight	
				lb.	kg
51992	690	230 V Machine Only	–	18¾	8,5
51987	690	115 V Machine Only	–	18¾	8,5
51997	690	230 V Machine Only (Switzerland Only)	–	18¾	8,5
41732	690-C	230 V 1/2" - 2" with Support Arm and Carrying Case	BSPT	55	25,0
41737	690-C	230 V 1/2" - 2" with Support Arm and Carrying Case (Switzerland Only)	BSPT	55	25,0
41967	690-C	115 V 1/2" - 2" with Support Arm and Carrying Case	BSPT	55	25,0
Accessories					
73442	418	Oiler with 5 litres of Thread Cutting Fluid		21½	9,8
43292	691	Support Arm for 690		4¾	2,0
13788	–	Metal Carrying Case for 690		13¼	6,0
39187	–	Ratchet Ring		1¼	0,5



Optional Carrying Case

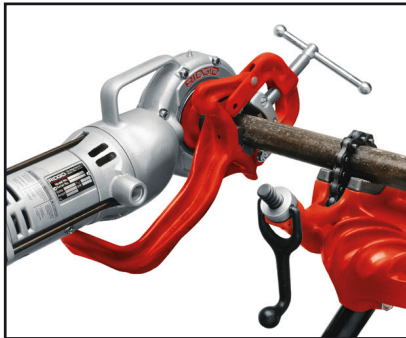

Model 700 Power Drive

- Heavy-duty hand-held power drive.
- Features reversible 1.100 W, 115 V or 230 V universal motor.
- Capacity 1/8 - 2" (6 - 50 mm) pipe, 1/4" - 1" (8 - 25 mm) bolt with OO-RB die heads. Designed for RIDGID No. 12-R die heads. Other RIDGID die heads (OO-R, OO-RB, 11-R) using adapters. Also used with 258/258XL pipe cutters.

Technical Specifications

- Motor: Universal, 1.100 W, 115 V or 230 V 50/60 Hz.
- Switch: Double-throw reversible.
- Gear Head: Spur gear reduction face gear drive. Spring-loaded adapter pawls. Hardened steel spindle gear.
- Body: Cast aluminum.
- Spindle Speed: 26 - 30 RPM (no load).
- Capacity: 1/8 - 2" Pipe (6 - 50 mm). 1/4 - 1" (8 - 25 mm) Bolt (using OO-RB Die Heads).
- Weight: 25 lbs. (11 kg) Power Drive only.
- Length: 28 1/4" (71,7 cm).

Catalog No.	Model No.	Description	Dies	Weight	
				lb.	kg
46832	700	115 V, 25 - 60 Hz	BSPT	30 3/4	14
12651	700	230 V, 25 - 60 Hz Double Insulated	BSPT	30 3/4	14
16251	700-C	115 V, 25 - 60 Hz 1/2 - 2" BSPT	BSPT	81 1/2	37
16241	700-C	230 V, 25 - 60 Hz 1/2 - 2" BSPT	BSPT	81 1/2	37
Accessories					
42600	770	Adapter for OO-R and OO-RB		4 3/8	2
42605	771	Adapter for O-R		4 3/8	2
42610	772	Adapter for 11-R and R-200 (1/8" - 1 1/4")		4 3/8	2
42615	773	Adapter for 111-R		2 3/16	1
42620	774	Square Drive Adapter - (1 5/16") 24 mm for 141 Geared Threader		4 3/8	2
42625	775	Support Arm for No. 700		11	5
42950	B-171-X	Metal Carrying Case for No. 700 and Accessories		28 3/4	13

700-C includes 12-R die heads (1/2" - 2"), carrying case and No. 775 support arm.

Model 300 Power Drive



Model 300 Power Drive Only

- RIDGID speed chuck.
- Universal, 1,5 kW reversible motor, single phase.
- Capacity: 1/8 - 2" (6 - 50 mm) pipe, 2 1/2 - 4" (65 - 100 mm) with 141, and 4 - 6" (100 - 150 mm) with 161 Geared Threaders; 1/4 - 2" (6 - 52 mm) rod.
- Recessed On/Off/Reverse switch.
- Ideal for use with RIDGID roll groovers, see page 5.1.
- Convert a 300 Power Drive to a portable threading machine, see page 4.17.

Technical Specifications

- Motor: Universal, 1,5 kW reversible motor, single phase, 230 V or 115 V, 50/60 Hz.
- Switch: Heavy-duty FOR/OFF/REV and Integral Foot Switch.
- Chuck: RIDGID speed chuck with replaceable rocker-action jaws.
- Spindle Speed: 38 RPM.
- Rear Centering Device: Cam-action turns with chuck.
- Support Bar: Heavy-duty (2).

Catalog No.	Model No.	Motor	Capacity	Speed RPM	Weight	
			in.		lb.	kg
60082	300	230 V, 25 - 60 Hz Universal	1/8 - 2	38	96	43,5
60077	300	115 V, 25 - 60 Hz Universal	1/8 - 2	38	96	43,5
10031	300A	230 V, 25 - 60 Hz Universal	1/8 - 2	38	95	43
10041	300A	115 V, 25 - 60 Hz Universal	1/8 - 2	38	95	43
Accessories						
42360	1206	Stand for 300 Power Drive			31	14,1
42575	32	Transporter (for Power Drives and TRISTAND Vises)			14 1/4	6,5
68815	311	Carriage with No. 312 Lever			15	6,8
42385	312	Carriage Feed Lever			3	1,4
42365	341	Reamer for No. 311 Carriage with Lever			7	3,2
73442	418	Oiler with 5 Litres of Thread Cutting Oil			21 1/2	9,8
42370	360	Cutter for No. 311 Carriage			8 1/2	3,9
97070	811A	Universal BSPT Q.O. Die Head Only, Right-Hand Only			12 1/2	5,7
97080	815A	Self-Opening BSPT Die Head Only, Right-Hand Only			13 1/2	6,1
68160	819	Nipple Chuck Complete, 1/2 - 2" BSPT (15 - 50 mm)			101 1/2	4,8
22638	1452	Clip-On Tool Tray			6	2,7
44715	E1666X	Jaw Insert Set			1/2	0,2
97365	-	Jaw Inserts for Coated Pipe			1/2	0,2
46660	E-863	LH/RH Reamer Cone			7	3,2
41620	-	Gearhead Motor Grease			1	0,5

Model 300 Power Drive Complete



Standard Equipment

- Model 300 Power Drive with footswitch.
- Model 811A or 815A universal die head.
- 1/2 - 3/4" universal alloy die set.
- 1 - 2" universal alloy die set.
- Model 360 Cutter: Capacity: 1/8 - 2" (6 - 50 mm) pipe, 1/4 - 7/8" (8 - 22 mm) rod with F-3 wheel, 5/16 - 1" (8 - 25 mm) with E-1032 cutter wheel.
- Model 341 Reamer: Positive-locking, 5-flute cone, right-hand 1/8 - 2" (6 - 50 mm). Special E863 RH/LH combination reamer cone available.
- Model 311 Carriage with lever.
- Model 1206 Stand.
- Oiler Model 418 or Oil Pan Assembly Model 330.



Model 32 Transporter



Model 1452 Tray

Catalog No.	Model No.	Motor	Oiler	Pipe Threading Capacity	Speed RPM	Die Head		Weight	
				in.		Quick Opening 811A	Automatic Opening 815A	lb.	kg
12891	300C	115 V, 25 - 60 Hz Universal, Manual Oiling	418	1/8 - 2	38	•	—	187	85
12881	300CA	230 V, 25 - 60 Hz Universal, Manual Oiling	418	1/8 - 2	38	—	•	185	84
13181	300AC	115 V, 25 - 60 Hz Universal, Automatic Oiling	330	1/8 - 2	38	•	—	209½	95
13191	300AAC	230 V, 25 - 60 Hz Universal, Automatic Oiling	330	1/8 - 2	38	—	•	209½	95

Model 535A Automatic Threading Machine



535A with optional 200A Machine Stand

Standard Equipment: machine only:

- Cutter: Model 820
- Reamer: Model 341
- Oil: 5 l Thread cutting fluid
- Spare E-1032 cutter wheel
- 2 hex wrenches ($\frac{5}{32}$ " , $\frac{3}{16}$ ")

Machine Complete: machine only, plus:

- Die head: Model 811-A or 815-A
- Dies: $\frac{1}{2}$ - $\frac{3}{4}$ " BSPT Alloy, 1 - 2" BSPT Alloy (Universal)
 $\frac{1}{2}$ - $\frac{3}{4}$ " BSPT HS, 1" - 2" BSPT HS (Induction)

Capacities

- Pipe: $\frac{1}{8}$ - 2" (6 - 50 mm) $2\frac{1}{2}$ - 4" (65 - 100 mm) with 141 geared threader.
- Bolt: $\frac{1}{4}$ - 2" (8 - 52 mm).

The Model 535A maintains the ruggedness of the industry workhorse while adding features that make the threading operation more productive. A large chip tray and oil reservoir make the Model 535A ideal for longer uninterrupted threading. The Model 535A features a high clearance carriage that makes the threading operation easier and a generous top cover area that is ideal for keeping tools and work related materials handy. The Model 535A is designed around maximum uptime with the upgrades that matter most to the pipe working professional. Users also benefit from the part commonality between the manual Model 535, the Model 535A Automatic and other RIDGID equipment.

Features

- Automatic chuck.
- Spindle speed: 36 (Universal) or Electrically switched 35/70 (3 phase).
- Large 6,6 l oil reservoir.
- Large chip tray.
- Generous top cover area for keeping tools and fittings handy.
- High clearance carriage.
- Can be used with geared threader Model 141.
- Uses Model 815A self opening or Model 811A quick-opening die heads.
- Length gauge for quick, accurate cut-off.

Technical Specifications

- Motor: Choice of Universal (1,5 kW) or Three Phase Induction Motors (1,35/1,7 kW).
- Switches: FOR/OFF/REV and Integral safety foot switch.
- Chuck: automatic with four reversible forged jaws.
- Rear Centering Device: automatic, centering only.
- Cutters: self-centering, full-floating. Two models available:
 - One Standard. Model 820 Wheel-Type Cutter, pipe capacity $\frac{1}{8}$ - 2" (6 - 50 mm), bolt capacity $\frac{1}{4}$ - 1" (8 - 25 mm).
 - Two Optional. Model 821 Blade-Type cutter, pipe capacity $\frac{1}{2}$ - 2" (15 - 50 mm). See ordering chart.
- Spindle speed: 36 (Universal) or Electrically switched 35/70 (3 phase).
- Reamer: 5-flute cone, RH, $\frac{1}{8}$ - 2" (6 - 50 mm).
- Oil Pump: self-priming gerotor oil pump.
- RH/LH combination reamer available.

Catalog No.	Model No.	Motor	Pipe Threading Capacity	Speed RPM	Die Head		Weight	
			in.		Quick Opening 811A	Automatic Opening 815A	lb.	kg
96067	535 Automatic Chuck Only	230 V, 25 - 60 Hz Universal	½ - 2	36	–	–	255¼	116
96072	535 Automatic Chuck Only	115 V, 25 - 60 Hz Universal	½ - 2	36	–	–	255¼	116
96057	535 Automatic Chuck Only	400 V, 50 Hz 3 Phase Induction	½ - 2	35 / 70	–	–	255¼	152
33471	535 Automatic Chuck Complete ½" - 2" BSPT	230 V, 25 - 60 Hz Universal	½ - 2	36	•	–	269	122
33481	535 Automatic Chuck Complete ½" - 2" BSPT	115 V, 25 - 60 Hz Universal	½ - 2	36	•	–	269	122
33491	535 Automatic Chuck Complete ½" - 2" BSPT	230 V, 25 - 60 Hz Universal	½ - 2	36	–	•	269	122
33501	535 Automatic Chuck Complete ½" - 2" BSPT	400 V, 50 Hz 3 Phase Induction	½ - 2	35 / 70	•	–	348¼	158
33511	535 Automatic Chuck Complete ½" - 2" BSPT	400 V, 50 Hz 3 Phase Induction	½ - 2	35 / 70	–	•	348¼	158

Optional Machine Stands



Model 100A



Model 150A



Model 200A with Steel Cabinet

Model 535A Machine Accessories

Catalog No.	Model No.	Description	Weight	
			lb.	kg
42365	341	Reamer	6¾	3,1
42390	820	Wheel-Type Cutter	8½	3,9
92457	100A	Universal Leg & Tray Stand	75	34,5
92462	150A	Universal Wheel & Tray Stand	103	46,7
92467	200A	Universal Wheel & Cabinet Stand	104	74,5
68160	819	Nipple Chuck Complete ½" - 2" BSPT	10½	4,8
41620	–	Gearhead Motor Grease	1	0,5
35867	839	Adapter Kit for 819 Nipple Chuck	16½	7,5
97882	535A	141 Mounting Kit	12	5,4
12138	535A	Left Hand Threading Kit	2½	1,2
42485	4U	Die Head Rack	8½	3,9
42490	6U	Die Head Rack	12½	5,7
97065	811A	NPT Die Head Quick-Open R.H.	12½	5,7
97075	815A	NPT Die Head Self-Open R.H.	13	5,9
23297	856	BSPT Die Head Quick-Open L.H.	12½	6,7
97070	811A	BSPT Die Head Quick-Open R.H.	12½	6,7
97080	815A	BSPT Die Head Self-Open R.H.	13	6,9
97045	531	Bolt Die Head Quick-Open R.H./L.H. ¼" - 1"	7½	3,4
97050	532	Bolt Die Head Quick-Open R.H./L.H. 1½" - 2"	9	4,1

Dies: All Universal Pipe and Bolt Dies; all 500B Bolt Dies, See pages 4.31 - 4.32

Steel Cabinet Features

- 17-gauge steel walls and welded construction.
- Two internal and one external storage shelves.
- Oversized bi-fold door with steel clasp.
- Cut-outs for power cord and foot switch storage.
- Two drain plugs for easy cleaning.

(TOOL TIP) Use High Speed Dies when threading at 45 RPM or greater.

Model 535 Threading Machine



Model 535

Standard Equipment: machine only:

- Cutter: Model 820
- Reamer: Model 341
- Oil: 5 l Thread cutting fluid
- Spare E-1032 cutter wheel
- 2 hex wrenches ($\frac{5}{32}$ " , $\frac{3}{16}$ ")

Machine Complete: machine only, plus:

- Die head: Model 811-A or 815-A
- Dies: $\frac{1}{2}$ " - $\frac{3}{4}$ " BSPT Alloy, 1" - 2" BSPT Alloy (Universal), $\frac{1}{2}$ " - $\frac{3}{4}$ " BSPT HS, 1" - 2" BSPT HS (Induction)

Capacities

- Pipe: $\frac{1}{8}$ - 2" (6 - 50 mm) $2\frac{1}{2}$ - 4" (65 - 100 mm), 4" - 6" (100 - 150 mm) with 141 and 161 geared threaders.
- Bolt: $\frac{1}{4}$ - 2" (6 - 52 mm).

The Model 535 maintains the ruggedness of the industry workhorse while adding the features that makes the threading operation more productive. A large chip tray and oil reservoir make the Model 535 ideal for longer uninterrupted threading. The Model 535 features a high clearance carriage making the threading operation easier and a generous top cover area that is ideal for keeping tools and work related materials handy. The Model 535 is designed around maximum uptime with the upgrades that matter most to the pipe working professional. Users also benefit from the part commonality between the Model 535, the Model 535A Automatic and other RIDGID equipment.

Features

- Large 6,6 l oil tray.
- Large chip tray.
- Generous top cover for keeping tools and fittings handy.
- High clearance carriage.
- Speed chuck with rocker-action jaws centers and grips work piece instantly.
- Can be used with geared threaders Models 141 and 161.
- Uses Model 815A self-opening or Model 811A quick-opening die heads.
- Length gauge for quick, accurate cut-off.

Technical Specifications

- Motor: Choice of Universal (1,5 kW) or Three Phase Induction Motors (1,35/1,7 kW).
- Switches: FOR/OFF/REV and Integral safety foot switch.
- Chuck: Speed Chuck with replaceable rocker-action jaw inserts (3).
- Rear Centering Device: Cam-action, turns with chuck.
- Cutters: Self-centering, full-floating. Two models available:
 - One Standard. Model 820 Wheel-Type Cutter, pipe capacity $\frac{1}{8}$ - 2" (6 - 50 mm), bolt capacity $\frac{1}{4}$ - 1" (8 - 25 mm).
 - Two Optional. Model 821 Blade-Type cutter, pipe capacity $\frac{1}{2}$ - 2" (15 - 50 mm). See ordering chart.
- Spindle speed: 36 (Universal) or Electrically switched 35/70 (3 phase).
- Reamer: 5-flute cone, RH, $\frac{1}{8}$ - 2" (6 - 50 mm).
- Oil Pump: Self-priming gerotor oil pump.
- RH/LH combination reamer available.

Catalog No.	Model No.	Motor	Pipe Threading Capacity	Speed RPM	Die Head		Weight	
			in.		Quick Opening 811A	Automatic Opening 815A	lb.	kg
96052	535 Manual Chuck Only	230 V, 25 - 60 Hz Universal	1/8 - 2	36	—	—	255 ³ / ₄	116
96062	535 Manual Chuck Only	115 V, 25 - 60 Hz Universal	1/8 - 2	36	—	—	255 ³ / ₄	116
96047	535 Manual Chuck Only	400 V, 50 Hz 3 Phase Induction	1/8 - 2	35 / 70	—	—	255 ³ / ₄	116
66630	535 Manual Chuck Complete 1/2 - 2" BSPT	230 V, 25 - 60 Hz Universal	1/8 - 2	36	•	—	251	114
10971	535 Manual Chuck Complete 1/2 - 2" BSPT	115 V, 25 - 60 Hz Universal	1/8 - 2	36	•	—	251	114
10981	535 Manual Chuck Complete 1/2 - 2" BSPT	230 V, 25 - 60 Hz Universal	1/8 - 2	36	—	•	251	114
12441	535 Manual Chuck Complete 1/2 - 2" BSPT	400 V, 50 Hz 3 Phase Induction	1/8 - 2	35 / 70	•	—	348	158
12451	535 Manual Chuck Complete 1/2 - 2" BSPT	400 V, 50 Hz 3 Phase Induction	1/8 - 2	35 / 70	—	•	348	158

Optional Machine Stands



No. 100A



No. 150A



No. 200A with Steel Cabinet

Model 535 Machine Accessories

Catalog No.	Model No.	Description	Weight	
			lb.	kg
42365	341	Reamer	6 ³ / ₄	3,1
42390	820	Wheel-Type Cutter	8 ¹ / ₂	3,9
97365	—	Jaw Inserts for Coated Pipe	1/2	0,2
92457	100A	Universal Leg & Tray Stand	75	34,5
92462	150A	Universal Wheel & Tray Stand	103	46,7
92467	200A	Universal Wheel & Cabinet Stand	104	74,5
58007	—	Machine stand adapter bracket for 535's built before 1996	17	7,7
96517	MJ-1	535M Left Hand Threading Kit	3 ¹ / ₂	1,6
42415	768	Drive Link Assembly for 141 (model 535)	2 ¹ / ₂	1,1
16723	4135	Drive Link Assembly for High Clearance Carriage for 141 (model 535M)	12	5,5
42405	844	Drive Bar for 141	5 ³ / ₄	2,6
51005	819	Nipple Chuck Complete 1/2 - 2"	10 ¹ / ₂	4,8
41620	—	Gearhead Motor Grease	1	0,5

Steel Cabinet Features

- 17-gauge steel walls and welded construction.
- Two internal and one external storage shelves.
- Oversized bi-fold door with steel clasp.
- Cut-outs for power cord and foot switch storage.
- Two drain plugs for easy cleaning.

Accessories

- Die Heads and Dies. (page 4.25 - 4.30)
- Die Head Racks. (page 4.25)
- Stands – Three Models Available.
- Thread Cutting Oil. (page 4.12)
- Nipple Chuck. (page 4.33)

Model 300 Compact Threading Machine

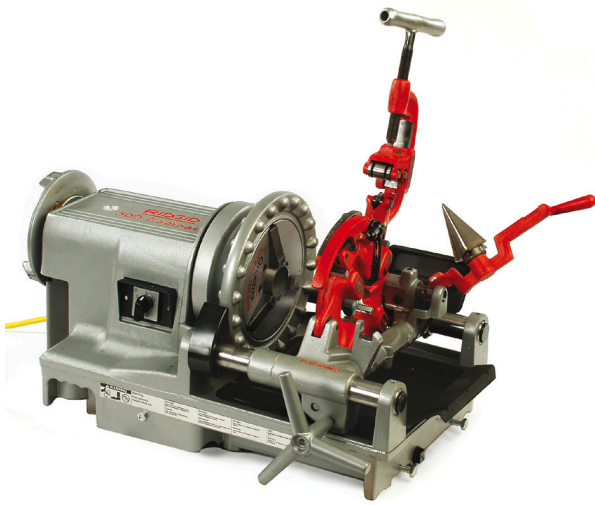

Capacity

- Pipe: 1/8 - 2" (6 - 50 mm).
- Bolt: 1/4 - 2" (6 - 52 mm).

Features

- Heavy-duty proven performance.
- Lightweight, portable design.
- Fast transport and set-up.
- Self-Contained Oil System with adjustable flow control.
- Versatility for threading and grooving.
- Quiet operation.

Technical Specifications

- Motor: 1,7 kW Universal 25 - 60 Hz.
- Motor Control: Heavy duty rotary FOR/OFF/REV with integral foot switch.
- Spindle Speed: 38 RPM.
- Chuck: Hammer-type with replaceable, rocker-action jaw inserts.
- Oiling System: Through-the-head, with integral oil reservoir. Self-priming, constant flow, gerotor pump.
- Cutter: Model 360, roll-type cutoff, self-centering, full-floating.
- Reamer: Model 344, 1/8 - 2", five flute cone, right hand only.

Standard Equipment

Model 300 compact threading machine with foot switch:

- One Model 815A (BSPT) 1/8 - 2", self-opening die head.
- One set 1/2 - 3/4" alloy universal dies.
- One set 1 - 2" alloy universal dies.
- One Model 360 cutter with E-1032 cutter wheel.
- One Model 344 reamer.
- Oil: 5 l Thread cutting fluid.

Catalog No.	Model No.	Motor	Pipe Threading Capacity	Speed RPM	Die Head Self Opening 815A	Weight	
			in.			lb.	kg
50697	300 Compact	230 V, 25 - 60 Hz Universal	1/8 - 2	38	•	154	70,0
50692	300 Compact	115 V, 25 - 60 Hz Universal	1/8 - 2	38	•	154	70,0
20391	300 Compact (DK)	230 V, 25 - 60 Hz Universal	1/8 - 2	38	•	154	70,0

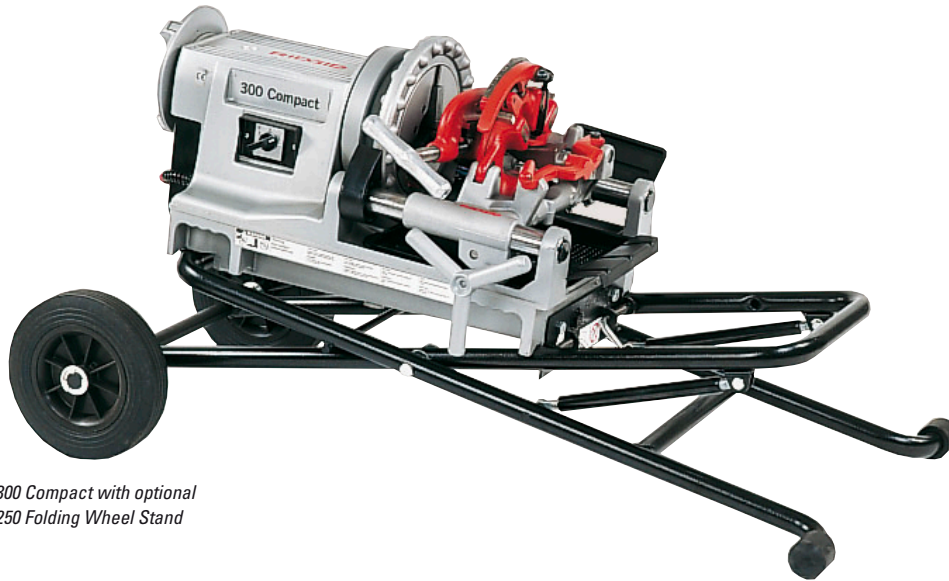

Model 300 Compact with optional
Model 250 Folding Wheel Stand

Catalog No.	Model No.	Description	Weight	
			lb.	kg
Die Heads				
97080	815A	1/8 - 2" BSPT, Self-Opening, RH	13	5,9
45322	815A	1/8 - 2" BSPT, Self-Opening, RH. Eur. RT	13	5,9
97075	815A	1/8 - 2" NPT, Self-Opening, RH	13	5,9
97070	811A	1/8 - 2" BSPT, Quick-Opening	12	5,4
97065	811A	1/8 - 2" NPT, Quick-Opening, RH	13	5,9
97045	531	1/4 - 1" Bolt, Quick-Opening, RH/LH	8	3,6
97050	532	1/4 - 2" Bolt, Quick-Opening, RH/LH	9	4,1
Accessories				
67662	–	916 Groover Adapter Bracket for 300 Power Drive version of 916	30	13,6
68160	819	Nipple Chuck, 1/2 - 2" BSPT	10,5	4,8
41620	–	Gearhead Motor Grease	1	0,5
Stands (see page 4.24)				
58077	250	Folding Wheel Stand	45	21,0
92457	100A	Universal Leg & Tray Stand	75	34,5
92462	150A	Universal Wheel & Tray Stand	103	46,7
92467	200A	Universal Wheel & Cabinet Stand	164	74,5

Threader Stands



Model 100A



Model 150A



Model 200A with steel cabinet



Model 250



Stands

Stands are available to satisfy every operational situation. The Model 250 Folding Wheel Stand provides increased field maneuverability and productivity. Pneumatic pistons allow the machine to be quickly raised to working height with minimum effort. (Not suitable for use with roll groover or 141 geared threader.)

Stands

Catalog No.	Model No.	Description	Weight	
			lb.	kg
92457	100A	Universal Leg & Tray Stand	75	34,1
92462	150A	Universal Wheel & Tray Stand	103	46,7
92467	200A	Universal Wheel & Cabinet Stand	104	47,2
58077	250	Folding Wheel Stand (for RIDGID 300 Compact and 1233)	45	21,0
22563	—	Steel Cabinet	42	19,3

Optional Die Heads

Catalog No.	Model No.	Die Head Description	How Opened	Thread Direction	Oil Thru Head	Dies Used	Pipe Cap.	Bolt Cap.	Used On	Weight	
										lb.	kg
Machine NPT Die Head											
97065	811A	Universal	Q.O.	RH	Yes	Univ.	1/8 - 2"	1/4 - 2"	R	12 1/2	5,7
97075	815A	Universal	S.O.	RH	Yes	Univ.	1/8 - 2"	1/4 - 2"	R	13	5,9
23282	842	Universal	Q.O.	LH	Yes	Univ.	1/8 - 2"	—	R	12 1/2	5,7
10491	555	555	Q.O.	RH	Yes	Dual/Bolt	1/8 - 3/4"	—	R	8	3,6
Machine BSPT Die Heads											
97070	811A	British Universal	Q.O.	RH	Yes	Univ.	1/8 - 2"	1/4 - 2"	R	12 1/2	5,7
97080	815A	British Universal	S.O.	RH	Yes	Univ.	1/8 - 2"	1/4 - 2"	R	13	5,9
45322	815A	British Universal Eur. RT	S.O.	RH	Yes	Univ.	1/8 - 2"	1/4 - 2"	R	13	5,9
23297	856	British Universal	S.O.	LH	Yes	Univ.	1/8 - 2"	—	R	12 1/2	5,7
10491	555	555	Q.O.	RH	Yes	Dual/Bolt	1/4 - 3/4"	—	R	8	3,6
Machine Bolt Die Heads											
97045	531	Bolt	Q.O.	RH/LH	Yes	500B	—	1/4 - 1"	R	7 1/2	3,4
97050	532	Bolt	Q.O.	RH/LH	Yes	500B	—	1 1/4 - 2"	R	9	4,1



No. 815A
Self-Opening
Die Head



No. 811A
Quick-Opening
Die Head

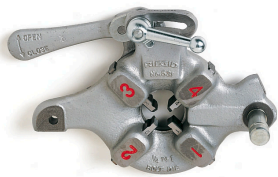

No. 532
Bolt Die Head



No. 856/842
Universal Die Head



No. 555 Die Head

R 1233 535-535A Machines and 300, 300 Compact and 300-A w/carriage.

Q.O. = Quick-Opening – Manually flip throwout lever to retract dies when thread length is cut.

S.O. = Self-Opening – Trigger foot automatically retracts dies when thread length is cut.

No. 811A Die Head replaces the No. 811 and No. 841 Die Heads.

No. 815A Die Head replaces the No. 815 and No. 845 Die Heads.

No. 555 Die Head replaces No. 515.

Note: British Die Heads use British Dies only.

Note: 531 and 532 Die Heads replace 500B Die Head.

Individual Machine Die Heads do not include dies.

Die Head Differences

- Self-Opening – Automatic release for repeatable number of threads.
- Quick-Opening – Manual release for user-specified thread lengths.
- Bolt – Specially for bolt threader.

Die Head Racks For All Machine Die Heads

Catalog No.	Model No.	Description	Weight	
			lb.	kg
42485	4U	4 Heads	8 1/2	3,9
42490	6U	6 Heads	12 1/2	5,7

Model 1233 Threading Machine



Capacities

- Pipe: ¼ - 3" (8 - 80 mm) 2½ - 4" (65 - 100 mm) with 141 Geared Threader.
- Bolt: 10 - 52 mm up to 30 RC.

Features

- Threads ¼ - 3" pipe at 36 RPM.
- Constant and proper lubrication of dies and workpiece with through-head oiling.
- Suitable for use with RIDGID 916, 918 and 975 Roll Groovers.

Technical Specifications

- Motor: 1,7 kW Universal 50 - 60 Hz.
- Switches: Reverse / Off / Forward, heavy duty, rotary-type plus integral footswitch.
- Spindle Speed: 36 RPM.
- Chuck: Hammer-type with replaceable rocker-action jaw inserts.
- Rear Centering Device: Cam action.
- Cutter: Model 763, ¼ - 3", self-centering, with E-1032 cutter wheel.
- Reamer: Model 743, ¼ - 3", 5-Fluted.
- Oiling System: Adjustable flow; through-the head, with an integral oil reservoir. Self-priming, constant-flow, geroter pump.

Catalog No.	Model No.	Motor	Capacity (BSPT)		Speed RPM	Die Head		Weight	
			in.			Self Opening 815A	Self Opening 928	lb.	kg
20215	1233	230 V, 50 - 60 Hz Universal	¼ - 3		36	•	•	178½	81
20220	1233	115 V, 50 - 60 Hz Universal	¼ - 3		36	•	•	178½	81
55212	1233	230 V, 50 - 60 Hz Universal	¼ - 2		36	•	—	156½	71

Standard Equipment

- Die Heads: Model 815A ¼ - 2", BSPT; Model 928A 2½ - 3", BSPT.
- Dies: ½ - ¾" BSPT Alloy. 1 - 2" BSPT Alloy. 2½ - 3" BSPT High Speed.
- Cutter: Model 763, ¼ - 3", self-centering, with E-1032 cutter wheel.
- Reamer: Model 743, ¼ - 3", 5-Fluted.
- Oil: 5 litres thread cutting fluid.

Optional Machine Stands



No. 100A



No. 150A



No. 200A with Steel Cabinet

Model 1233 Stands

Catalog No.	Model No.	Description	Weight	
			lb.	kg
92457	100A	Universal Leg & Tray Stand	75	34,1
92462	150A	Universal Wheel & Tray Stand	103	46,7
92467	200A	Universal Wheel & Cabinet Stand	104	47,2
58077	250	Folding Wheel Stand (for RIDGID 300 Compact and 1233)	45	21,0
22563	-	Steel Cabinet	42	19,3

Die Heads for Model 1233

Catalog No.	Model No.	Description	Weight	
			lb.	kg
97080	815A	1/8" - 2" BSPT, Self-Opening, RH	13	5,9
45322	815A	1/8" - 2" BSPT, Self-Opening, RH. Eur. RT	13	5,9
97075	815A	1/8" - 2" NPT, Self-Opening, RH	13	5,9
97070	811A	1/8" - 2" BSPT, Quick-Opening	12	5,4
97065	811A	1/8" - 2" NPT, Quick-Opening, RH	13	5,9
97045	531	1/4" - 1" Bolt, Quick-Opening, RH/LH	8	3,6
97050	531	1/4" - 2" Bolt, Quick-Opening, RH/LH	9	4,1
93562	928	2 1/2" - 3" BSPT, Self-Opening, RH	18	8,2
54437	728	2 1/2" - 3" NPT, Self-Opening, RH	18	8,2

Pipe Dies 2 1/2" - 3" (for 1/4" - 2" see pages 4.30 - 4.31)

Die Material or Type	BSPT	NPT
Nominal Pipe Size inch x TPI	2 1/2" x 3" x 11 TPI	2 1/2" x 3" x 8 TPI
High-Speed RH	51377	54452

Model 1224 Threading Machine



Model 1224

Capacities

- Pipe: ¼ - 4" (8 - 100 mm) 4 - 6" (100 - 150 mm) with 161 Geared Threader.
- Bolt: ¼ - 2" (6 - 52 mm).

Features

- Threads ¼ - 2" pipe at 36 RPM and 2½ - 4" at 12 RPM.
- The Model 1224 threads a wide range of pipe including black, galvanized and plastic-coated pipe, together with stainless steel, IMC and heavy-wall conduit, as well as rod up to 30 Rockwell C.
- An induction motor insures sound levels well within the limits set by the regulating authorities.
- A special capacitor-start / capacitor-run motor allows the Model 1224 to thread a full range of material where voltage drop is experienced.
- ¼ - 2" Universal Die Head; 2½ - 4" receding die head allows cutting of tapered or straight NPT/NPSM or BSPT/BSPP threads.
- Constant and proper lubrication of dies and workpiece with through-head oiling.

Technical Specifications

- Motor: 1,1 kW, single-phase, 50 Hz induction type.
- Switches: Reverse / Off / Forward, heavy-duty, rotary-type and integral foot switch.
- Spindle Speed: 36/12 RPM.
- Gear Box: Two-speed gear box 3:1 ratio.
- Chuck: Hammer-type with replaceable rocker-action jaw inserts.
- Rear Centering Device: Cam action.
- Cutter: Model 764 full-floating, self-centering ¼ - 4" with F-229 cutter wheel.
- Reamer: Model 744, ¼ - 4" blade-type.
- Oiling: Through die head.
- Pump: Self-priming, gerotor-type, automatic-reversing, constant-flow.

Catalog No.	Model No.	Motor	Capacity (BSPT) in.	Speed RPM	Die Head		Weight	
					Self Opening 911	Self Opening 914	lb.	kg
26107	1224	230 V, 50 Hz Induction (BSPT)	¼ - 4	36/12	•	•	463	210
26112	1224	115 V, 50 Hz Induction (BSPT)	¼ - 4	36/12	•	•	463	210
31442	1224	230 V, 50 Hz Induction (NPT)	¼ - 4	36/12	711 Die Head	714 Die Head	463	210

Model 1224 Stands

Catalog No.	Model No.	Description	Weight	
			lb.	kg
92457	100A	Universal Leg & Tray Stand	75	34,5
92462	150A	Universal Wheel & Tray Stand	103	46,7
92467	200A	Universal Wheel & Cabinet Stand	164	74,5
22563	—	Steel Cabinet	42	19,3

Standard Equipment

Model 1224 threading machine with foot switch:

- One Model 714 (914) 2½ - 4" receding self-opening die head.
- One Model 711 (911) ¼ - 2" universal self-opening die head.
- One set ½ - ¾" universal alloy dies.
- One set 1 - 2" universal alloy dies.
- One set 2½ - 4" 1224 high-speed dies.

- One Model 764 cutter.
- One Model 744 reamer.
- One spare F-229 cutter wheel.
- Oil: 5 Litres thread cutting fluid.
- Three (3) hex keys.
- Tools and equipment: 4 Hex keys, heavy-duty F-229 cutter wheel, ¾" combination wrench, tool box.



Model 541
Model 542



Model 713
Model 913

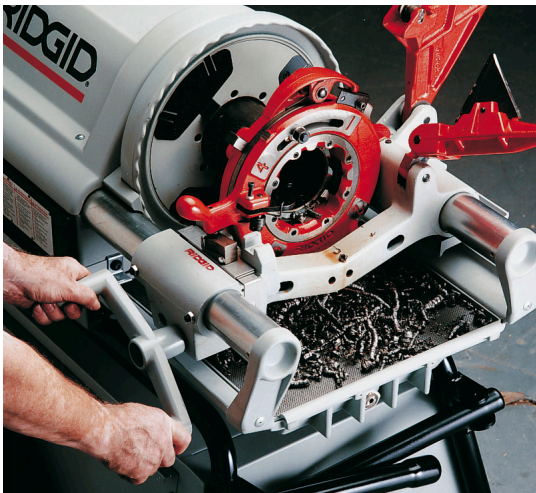

Model 714 (914) Style Receding Die Head.

Die Heads for Model 1224

Catalog No.	Model No.	Description	Capacity		Weight	
			in.	lb.	kg	
26132	711	Universal Self-Opening R.H., NPT	¼ - 2	12¼	5,6	
26152	714	Receding Self-Opening R.H., NPT	2½ - 4	30	13,6	
26137	911	Universal Self-Opening R.H., BSPT	¼ - 2	12¼	5,6	
26157	914	Receding Self-Opening R.H., BSPT	2½ - 4	30	13,6	
26162	541	Quick-Opening Bolt L.H./R.H.	¼ - 1	7½	3,4	
26167	542	Quick-Opening Bolt L.H./R.H.	1½ - 2	9¼	4,2	
55447	725	Cut-Grooving Die Head (does not include dies)	2½ - 4	30	13,6	
57497	-	2½ - 3½" Grooving Die Set	2½ - 3½	2¼	1,0	
57507	-	2½ - 3½" Grooving Bit only	-	-	-	
57492	-	4" Grooving Die Set	4	2¼	1,0	
57502	-	4" Grooving Bit only	-	-	-	
55452	766	Blade Type Cutter	¾ - 4	21	9,5	

Note: Die Heads do not include dies. All Die Heads are through-head oiling.

Pipe Dies 2½" - 4" (for ¼" - 2" see pages 4.30 - 4.31)

Catalog No.	Description	Capacity		Weight	
		in.	lb.	kg	
26192	1224 H.S. Dies NPT	2½ - 4	2¼	1,0	
33642	1224 H.S. Dies BSPT	2½ - 4	2¼	1,0	
31827	1224 H.S. NPT Dies for Plastic-Coated Pipe	2½ - 4	2¼	1,0	
31832	1224 H.S. BSPT Dies for Plastic-Coated Pipe	2½ - 4	2¼	1,0	
32237	1224 H.S. Dies NPT for PVC	2½ - 4	2	1,0	
32242	1224 H.S. Dies BSPT for PVC	2½ - 4	2	1,0	
33057	1224 H.S. Dies NPT for Stainless Steel	2½ - 4	2	1,0	
33072	1224 45° Beveling Dies	2½ - 4	2	1,0	
33077	1224 37½° Beveling Dies	2½ - 4	2	1,0	
44992	1224 Bevel Guide Set	2½ - 4	2	1,0	
44997	1224 37½° Bevel Bit Only	-	-	-	
45002	1224 45° Bevel Bit Only	-	-	-	

Note: NPSM/BSPP threads are made with NPT/BSPT by adjusting the die head. See manual for details.

Accessories

Catalog No.	Model No.	Description	Capacity		Weight	
			in.	lb.	kg	
26212	764	¼" - 4" Wheel-Type Cutter	-	19	8,6	
26217	744	¼" - 4" Blade-Type Reamer	-	13	5,9	
34577	-	¼" - 4" Reamer Blade	-	½	0,2	
26187	-	Jaw Insert and Roll Set for PE-Coated Pipe	-	¼	0,1	
51005	819	Nipple Chuck (See page 4.33)	½ - 2	10½	4,8	
34157	419	Nipple Chuck 2½" NPT	-	5½	2,5	
34162	419	Nipple Chuck 3" NPT	-	5½	2,5	
34167	419	Nipple Chuck 4" NPT	-	5½	2,5	
34172	419	Nipple Chuck 2½" BSPT	-	5½	2,5	
34177	419	Nipple Chuck 3" BSPT	-	5½	2,5	
34182	419	Nipple Chuck 4" BSPT	-	5½	2,5	
61122	840A	Universal Drive Shaft	-	31	14,1	
26707	-	Gear Grease (1224 & 1822)	-	1	0,5	

Pipe Dies for Machine Die Heads



Pipe Dies for use in Universal Die Heads (Models 504A, 711, 713, 811A, 815A, 816, 817 and 842)*

Die Material or Type	(NPT)				(NPSM)			
	Nominal Pipe Size-Threads Per Inch				Nominal Pipe Size-Threads Per Inch			
	1/8" - 27	1/4" - 3/8" - 18	1/2" - 3/4" - 14	1" - 2" - 11 1/2	1/8" - 27	1/4" - 3/8" - 18	1/2" - 3/4" - 14	1" - 2" - 11 1/2
Alloy RH	47735	47740	47745	47750	—	—	—	—
High-Speed RH	47755	47760	47765	47770	47845	47850	47855	47860
High-Speed • LH	39587	47810	47815	47820	—	—	—	—
H.S. For Stainless Steel RH	47775	47780	47785	47790	—	—	—	—
H.S. For Cast Iron	—	—	—	70740	—	—	—	—
H.S. For PVC RH	—	—	70745	70750	—	—	—	—
H.S. For Plastic Coated Pipe RH	—	—	50012	31822	—	—	—	—

• Requires left hand model die head.
 Note: Use HS for PVC and RH for brass pipe.
 * Requires NPT model die head.

Pipe Dies for use in British Universal Die Heads (Models 504A, 811A, 815A, 816, 817, 856, 911 and 913)*

Die Material or Type	(BSPT)				(BSPP)			
	Nominal Pipe Size-Threads Per Inch				Nominal Pipe Size-Threads Per Inch			
	1/8" - 28	1/4" - 3/8" - 19	1/2" - 3/4" - 14	1" - 2" - 11	1/8" - 28	1/4" - 3/8" - 19	1/2" - 3/4" - 14	1" - 2" - 11
Alloy RH	66655	66660	18951	18961	—	—	—	—
High-Speed RH	66750	66755	18971	18981	66795	66800	66805	66810
H.S. For Stainless Steel RH (Gold)	66770	66775	57082	57087	—	—	—	66830
HS LH	—	—	66845	66850	—	—	—	—
H.S. For PVC RH	—	—	70755	70760	—	—	—	—
H.S. For PE-Coated RH	—	—	23996	23986	—	—	—	—

* Requires British model die head.

Conduit Dies for Universal Die Heads

Die Material or Type	(ISO)		(BEC)		
	Nominal Conduit Size – Pitch in mm		Nominal Conduit Size – Threads Per Inch		
	16 - 32 mm - 1,5	40 - 63 mm - 1,5	1/2" - 5/8" - 18	3/4" - 1 1/4" - 16	1 1/2" - 2 1/2" - 14
Alloy RH	50645	50650	66700	66705	66710

Pipe Dies for Models 514 (LH), 515 (RH), 555 (RH), and 1/2" - 3/4" Dual Die Heads

Die Material or Type	(NPT)			(BSPT)	
	Nominal Pipe Size-Threads Per Inch			Nominal Pipe Size-Threads Per Inch	
	1/8" - 27	1/4" - 3/8" - 18	1/2" - 3/4" - 14	1/4" - 3/8" - 19	1/2" - 3/4" - 14
Alloy RH	—	47875	47880	66955	66880
High-Speed RH	47885	47890	47895	66905	23297
H.S. For Stainless Steel RH	47900	47905	47910	—	66920

Pipe Dies, Bolt Dies for Machine Die Heads



Bolt Dies for Universal Die Heads (Models 504A, 711, 811A, 815A, 816, 817 and 911 Die Heads)

	(UNC)		(UNF)		(BSW)
Rod Size – TPI	RH High-Speed	Rod Size – TPI	RH High-Speed	Rod Size – RH TPI	High-Speed
1/4" - 20	48215	1/4" - 28	48295	1/4" - 20	*67880
5/16" - 18	48220	–	–	5/16" - 18	*67885
3/8" - 16	48225	3/8" - 24	48305	3/8" - 16	*67890
7/16" - 14	48230	7/16" - 20	48310	7/16" - 14	–
1/2" - 13	48235	1/2" - 20	48315	1/2" - 12	*67900
9/16" - 12	48240	9/16" - 18	48320	9/16" - 12	*67905
5/8" - 11	48245	5/8" - 18	48325	5/8" - 11	*67910
3/4" - 10	48250	3/4" - 16	48330	3/4" - 10	*67915
7/8" - 9	48255	7/8" - 14	48335	7/8" - 9	67920
1" - 8	48260	1" - 14NS	48340	1" - 8	*67925
1 1/8" - 7	48265	1" - 12	48375	1 1/8" - 7	–
1 1/4" - 7	48270	1 1/8" - 12	48345	1 1/4" - 7	*67935
1 3/8" - 6	48275	1 1/4" - 12	48350	1 3/8" - 6	–
1 1/2" - 6	48280	1 3/8" - 12	48355	1 1/2" - 6	*67945
1 3/4" - 5	48285	1 1/2" - 12	48360	1 3/4" - 5	–
2" - 4 1/2	48290	–	–	2" - 4 1/2	–

* Requires British model die head.

Bolt Dies for Models 500B, 532 and 542 Die Heads

(8 UN)	
Rod Size – TPI	RH High-Speed
1 1/8" - 8	49215
1 1/4" - 8	49220
1 3/8" - 8	49225
1 1/2" - 8	49230
1 3/4" - 8	49240
1 7/8"	49245
2" - 8	49250
(12 UN)	
2" - 8	49345

Beveling Dies

For beveling pipe prior to welding. A set of beveling dies consists of three guide segments and one cutting segment.

Catalog No.	Description	Pipe Size	Used in Die Head	Weight	
		in.		lb.	kg
52192	37 1/2° Bevel Die Set	1/2 - 3/4	Universal	1	0,5
50960	37 1/2° Bevel Die Set	1 - 2	Universal	1	0,5
52202	45° Bevel Die Set	1/2 - 3/4	Universal	1	0,5
50965	45° Bevel Die Set	1 - 2	Universal	1	0,5

Cut Grooving Dies

To cut groove pipe for mechanical type couplings, consult chart for sizes and die head information.

Catalog No.	Description	Pipe Size	Used in Die Head	Weight	
		in.		lb.	kg
52217	Grooving Die Set	1/2 - 3/4	Universal	1	0,5
50985	Grooving Die Set	1 - 2	Universal	1	0,5

Note: 2 1/2 - 4 Beveling Dies are available for the Model 1224 threading Machine. See accessories for Model 1224.

Note: Universal Dies fit all Universal Die Heads.

(TOOLTIP) Keep dies used for stainless steel separate from those used with black iron to avoid material contamination.



Bolt Dies for Models 500B and 531, 532, 541 and 542 Die Heads (Continued)

(UNC)			(UNF)	
Rod Size – TPI	RH High-Speed	LH High-Speed	Rod Size – TPI	RH High-Speed
1/4" - 20	48605	—	1/4" - 28	48690
5/16" - 18	48610	48915	5/16" - 24	48695
3/8" - 16	48615	48920	3/8" - 24	48700
7/16" - 14	48620	48925	7/16" - 20	48705
1/2" - 13	48625	48930	1/2" - 20	48710
9/16" - 12	48630	48935	9/16" - 18	48715
5/8" - 11	48635	48940	5/8" - 18	48720
3/4" - 10	48640	48945	3/4" - 16	48725
7/8" - 9	48645	48950	7/8" - 14	48730
1" - 8	48650	48955	1" - 12	48735
1 1/8" - 7	48655	48960	1" - 14NS	49305
1 1/4" - 7	48660	48965	1 1/8" - 12	48740
1 3/8" - 6	48665	48970	1 1/4" - 12	48745
1 1/2" - 6	48670	48975	1 3/8" - 12	—
1 3/4" - 5	48675	—	1 1/2" - 12	48755
2" - 4 1/2	48680	48985	—	—

For use with Models 531, 541 and 500B 1/4" - 1" Die Heads

For use with Models 532, 542 and 500B 1 1/8" - 2" Die Heads

(BSW)	
Rod Size – TPI	RH High-Speed
1/4" - 20	—
5/16" - 18	—
3/8" - 16	67615
7/16" - 14	67620
1/2" - 12	67625
9/16" - 12	—
5/8" - 11	67635
3/4" - 10	67640
7/8" - 9	67645
1" - 8	67650
1 1/8" - 7	67655
1 1/4" - 7	67660
1 3/8" - 6	67665
1 1/2" - 6	—
1 5/8" - 5	67675
1 3/4" - 5	—
1 7/8" - 4 1/2	67685
2" - 4 1/2	—

For use with Models 531, 541 and 500B 1/4" - 1" Die Heads

For use with Models 532, 542 and 500B 1 1/8" - 2" Die Heads

Dies for Rebar, for use in Models 500B, 531, 532, 541 and 542 Die Heads

Cat No.			
(UNC)			
RH High-Speed	Rebar Size – TPI	RH High-Speed	Rebar Size – TPI
34077	3/8" - 16	79120	1 1/8" - 7
34082	1/2" - 13	85855	1 3/8" - 6
34087	5/8" - 11	—	—
34092	3/4" - 10	—	—
85850	1" - 8	—	—

For use with Models 531, 541 and 500B 1/4" - 1" Die Heads

For use with Models 532, 542 and 500B 1 1/8" - 2" Die Heads

Acme		(S.I.) Series A Metric			Series B Metric		(ISO) International Standards. Org.	
Rod Size – TPI	RH High-Speed	Rod Size Thread Pitch in. mm	RH High-Speed	LH High-Speed	Rod Size Thread Pitch in. mm	RH High-Speed	Rod Size Thread Pitch in. mm	RH High-Speed
—	—	M6-1.0	49795	49845	—	—	M6-1.0	50040
—	—	M7-1.0	—	49850	—	—	M7-1.0	—
—	—	M8-1.25	49805	—	—	—	M8-1.25	50050
—	—	M9-1.25	—	—	—	—	M9-1.25	—
—	—	M10-1.5	49815	—	M10-1.0	50560	M10-1.5	50060
—	—	M11-1.5	49820	49870	—	—	M11-1.5	—
3/4" - 6	49610	M12-1.75	49825	49875	M12-1.5	85865	M12-1.75	50070
—	—	M14-2.0	49830	—	M14-1.5	—	M14-2.0	50075
—	—	M16-2.0	49835	—	M16-2.0	50575	M16-2.0	50080
—	—	M18-2.5	49840	49890	—	—	M18-2.5	50085
—	—	M20-2.5	50480	49895	M20-1.5	50585	M20-2.5	50090
—	—	M22-2.5	50485	49900	M22-1.5	50590	M22-2.5	50095
1" - 5	49585	M24-3.0	50490	49905	M24-2.0	85870	M24-3.0	50100
—	—	M25-3.0	50495	—	—	—	M27-3.0	50105
—	—	M26-3.0	76797	—	—	—	M30-3.5	50110
—	—	M27-3.0	50500	—	M27-2.0	—	M33-3.5	50115
—	—	M30-3.5	50505	49915	M30-2.0	—	M36-4.0	50120
1 1/4" - 5	49600	M33-3.5	50510	—	—	—	M39-4.0	50125
—	—	M36-4.0	50515	49925	—	—	M42-4.5	50130
1 3/8" - 4	—	M39-4.0	50520	49930	—	—	M45-4.5	—
—	—	M42-4.5	50525	—	—	—	M48-5.0	50140
—	—	M45-4.5	50530	—	—	—	M52-5.0	—
—	—	M48-5.0	50540	—	—	—	—	—
—	—	M50-5.0	50545	—	—	—	—	—
—	—	M52-5.0	50550	—	—	—	—	—

For use with Models 531, 541 and 500B 1/4" - 1" Die Heads

For use with Models 532, 542 and 500B 1 1/8" - 2" Die Heads

Nipple Chucks / Adapters

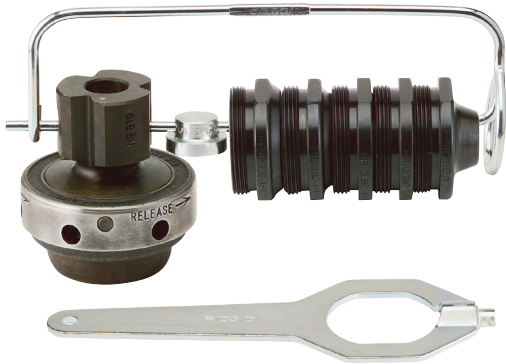

819 Nipple Chuck Kit

- Holds short or close nipples for threading.
- For use with Model 300 Power Drive, 300 Compact, 535 and 1822 (with adapter kit) and 1224 Threading Machines.
- Standard Nipple Chuck includes insert and 5 adapters: ½", ¾", 1", 1¼" and 1½". (Nipple Chuck body serves as 2" Adapter.)

Catalog No.	Model No.	Description	Weight	
			lb.	kg
51005	819	NPT Nipple Chuck ½ - 2"	10	4,5
68160	819	BSPT Nipple Chuck ½ - 2"	10	4,5
51020	D-380-X	Nipple Chuck Wrench	¼	0,1
35867	839	Adapter Kit for Model 1822/535A Machine	16½	7,5
62457	1219	NPT Nipple Chuck for 1215	5¾	2,6

Pipe Adapters

For use with Model 819 Nipple Chuck to allow close nipple threading of all sizes of pipe smaller than 2 inches.

Size (in.)	Model No.		BSPT Standard		Weight	
	Catalog No.	Model No.	Catalog No.	Model No.	lb.	kg
⅛	51040	E-729	—	—	½	0,23
¼	51045	E-730	68195	E-730-B	½	0,23
⅜	51050	E-731	68200	E-731-B	½	0,23
½	51055	E-732	68165	E-732-B	½	0,23
¾	51060	E-733	68170	E-733-B	½	0,23
1	51065	E-734	68175	E-734-B	½	0,23
1¼	51070	E-735	68180	E-735-B	½	0,23
1½	51075	E-736	68185	E-736-B	½	0,23