









W Range Solder Ring Fittings











GENERAL RANGE

- Fittings are manufactured from copper and copper alloy
- Available in sizes from 8-54mm
- Fittings are designed for jointing copper tubes to BS EN 1057 in hot and cold water services, in small bore and minibore central heating, low pressure steam heating, and in vented and unvented closed circuit heating systems
- WRAS approved.
- Manufactured to BS EN 1254 Part 1

	Size	Pk 1	Pk 2	Code
MSR1 Straight coupling copper x copper 	8mm	10	500	901001
	10mm	10	400	901003
	15mm	10	350	901010
	22mm	10	150	901020
	28mm	10	100	901030
	35mm	10	40	901032
	42mm	2	20	901034
54mm	2	20	901035	
MSR1IM Slip coupling adaptor. Imperial x metric copper x copper. To connect imperial tube to metric tube 	1/2" x 15mm	10	300	901040
	3/4" x 22mm	10	120	901050
MSR1R Reducing coupling copper x copper 	10 x 8mm	10	400	901057
	15 x 8mm	10	300	901058
	15 x 10mm	10	300	901059
	22 x 15mm	10	120	901063
	28 x 22mm	10	80	901066
MSR15 Straight coupling, slip pattern copper x copper 	15mm	10	300	901037
	22mm	10	120	901038
MSR2 Straight female connector copper x BSP parallel female thread 	15mm x 1/2"	10	200	901090
	22mm x 3/4"	10	120	901092
	28mm x 1"	5	50	901093
MSR3 Straight male connector copper x BSP taper male thread 	15mm x 1/2"	10	200	901114
	22mm x 3/4"	10	100	901116
	28mm x 1"	10	80	901118
	35mm x 1.1/4"	1	25	901119
	42mm x 1.1/2"	1	20	901120
	54mm x 2"	1	12	901121

	Size	Pk 1	Pk 2	Code
MSR6 Reducer larger end for insertion into fitting 	10 x 8mm	10	500	901191
	15 x 8mm	10	350	901194
	15 x 10mm	10	300	901196
	22 x 15mm	10	150	901200
	28 x 15mm	10	150	901202
	28 x 22mm	10	120	901204
	35 x 15mm	10	100	901206
	35 x 22mm	10	80	901207
	35 x 28mm	10	80	901208
	42 x 15mm	1	30	901209
	42 x 22mm	1	30	901210
	42 x 28mm	1	30	901211
	42 x 35mm	1	30	901212
	54 x 15mm	1	26	901213
	54 x 22mm	1	26	901214
	54 x 28mm	1	26	901215
54 x 35mm	1	26	901216	
54 x 42mm	1	26	901217	
MSR12 Elbow copper x copper 	8mm	10	400	901266
	10mm	10	350	901268
	15mm	10	200	901280
	22mm	10	120	901290
	28mm	10	60	901300
	35mm	5	30	901302
	42mm	2	16	901304
54mm	2	12	901306	
MSR12S Street elbow female copper x male copper for insertion into fitting 	15mm	10	200	901318
	22mm	10	120	901320
	28mm	10	60	901322
MSR13 Male elbow copper x BSP taper male thread 	15mm x 1/2"	10	240	901333
MSR15 Backplate elbow copper x BSP parallel female thread. Triangular backplate three hole fixing 	15mm x 1/2"	10	50	901365
MSR21 Elbow obtuse copper x copper 	15mm	10	250	901410
	22mm	10	100	901412
	28mm	10	50	901414
	35mm	2	40	901416
	42mm	1	16	901417
	54mm	1	12	901418
MSR24 Equal tee all ends for copper 	10mm	10	300	901443
	15mm	10	150	901450
	22mm	10	80	901460
	28mm	10	40	901462
	35mm	1	20	901464
	42mm	1	15	901466
	54mm	1	8	901467

	Size	Pk 1	Pk 2	Code	
	MSR25 Tee, reduced branch all ends for copper	22 x 22 x 15mm	10	80	901490
		28 x 28 x 15mm	10	40	901492
		28 x 28 x 22mm	10	40	901494
		35 x 35 x 15mm	1	15	901496
		35 x 35 x 22mm	1	15	901497
		35 x 35 x 28mm	1	15	901498
		42 x 42 x 15mm	1	10	901499
		42 x 42 x 22mm	1	10	901500
		42 x 42 x 28mm	1	10	901501
		42 x 42 x 35mm	1	10	901502
		54 x 54 x 15mm	1	10	901503
		54 x 54 x 22mm	1	10	901504
		54 x 54 x 28mm	1	10	901505
	54 x 54 x 35mm	1	10	901506	
	54 x 54 x 42mm	1	10	901507	
	MSR26 Tee, one end reduced all ends for copper	22 x 15 x 22mm	10	80	901510
		28 x 15 x 28mm	10	40	901512
		28 x 22 x 28mm	10	40	901514
	MSR27 Tee, one end and branch reduced all ends for copper	22 x 15 x 15mm	10	80	901530
		28 x 22 x 15mm	10	40	901536
		28 x 22 x 22mm	10	40	901538
	MSR28 Tee, both ends reduced all ends for copper	15 x 15 x 22mm	10	80	901551
	MSR30 Female tee copper ends x BSP parallel female branch	15 x 15mm x 1/2"	10	120	901585
	MSR61 Stop end for use on copper tube	8mm	10	700	901670
		10mm	10	700	901672
		15mm	10	300	901680
		22mm	10	200	901682
	MSR62 Tap connector copper x BSP union nut. Spigot and washer joint	15mm x 1/2"	10	160	901700
		15mm x 3/4"	10	100	901702
		22mm x 3/4"	10	100	901710
	MSR63 Bent tap connector copper x BSP union nut. Spigot and washer joint	15mm x 1/2"	10	120	901270

	Size	Pk 1	Pk 2	Code	
	MSR64 Bent union adaptor copper x BSP union nut. Cone joint to BS 1010	22mm x 1"	5	40	901732
	MSR68 Union adaptor copper x BSP union nut. Cone joint to BS 1010	22mm x 1"	10	80	901784

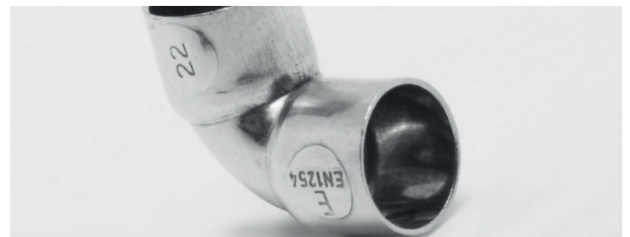









E Range End Feed Fittings

GENERAL RANGE

- Designed for end-feeding with soft solder or hard solder (brazing alloy)
- Available in sizes from 8-54mm, ideal for use in hot and cold water services, central heating, fuel services and general engineering applications
- WRAS approved.
- Manufactured to BS EN 1254 Part 1

	MEF1 Straight coupling copper x copper	8mm	10	600	901800
		10mm	10	500	901801
		15mm	10	350	901802
		22mm	10	150	901803
		28mm	10	100	901804
		35mm	10	50	901805
		42mm	1	15	901806
	54mm	1	10	901807	
	MEF1IM Adaptor coupling imperial copper x metric copper. To connect imperial tube to metric tube	1/2" x 15mm	10	350	901828
		3/4" x 22mm	10	150	901829
		1" x 28mm	10	100	901830
	MEF1R Reducing coupling copper x copper	10 x 8mm	10	500	901831
		15 x 10mm	10	350	901832
		22 x 15mm	10	150	901833
		28 x 15mm	10	100	901834
		28 x 22mm	10	100	901835

	Size	Pk 1	Pk 2	Code
MEF1S Slip/5270S Straight coupling, slip pattern copper x copper	15mm	10	350	901836
	22mm	10	150	901837
	28mm	10	100	901838
				
MEF2 Straight female connector copper x BSP parallel female thread	15mm x 1/2"	10	200	901839
	22mm x 3/4"	10	100	901840
	28mm x 1"	10	60	901841
				
MEF3 Straight male connector copper x BSP taper male thread	15mm x 1/2"	10	300	901896
	22mm x 3/4"	10	120	901897
	28mm x 1"	10	80	901898
	35mm x 1 1/4"	1	25	901899
	42mm x 1 1/2"	1	15	901900
	54mm x 2"	1	30	901901
				
MEF6 Reducer larger end male copper for insertion into fitting x female copper	10 x 8mm	10	500	901902
	15 x 8mm	10	350	901903
	15 x 10mm	10	350	901904
	22 x 15mm	10	150	901905
	28 x 15mm	10	100	901906
	28 x 22mm	10	100	901907
	35 x 15mm	10	50	901908
	35 x 22mm	10	50	901909
	35 x 28mm	10	50	901910
	42 x 15mm	1	20	901911
	42 x 22mm	1	20	901912
	42 x 28mm	1	20	901913
	42 x 35mm	1	20	901914
	54 x 15mm	1	10	901915
	54 x 22mm	1	30	901916
54 x 28mm	1	10	901917	
54 x 35mm	1	10	901918	
54 x 42mm	1	10	901919	
				
MEF12 Elbow copper x copper	8mm	10	500	901808
	10mm	10	450	901809
	15mm	10	200	901810
	22mm	10	120	901811
	28mm	10	60	901812
	35mm	1	20	901813
	42mm	1	15	901814
	54mm	1	10	901815
				
MEF12S Street elbow female copper x male copper for insertion into fitting	10mm	10	450	901816
	15mm	10	200	901817
	22mm	10	120	901818
	28mm	10	60	901819
	35mm	1	20	901820
	42mm	1	15	901821
54mm	1	10	901822	
				
MEF13 Male elbow copper x BSP taper male thread	15mm x 1/2"	10	320	901823
	22mm x 3/4"	10	80	901824
				
MEF14 Female elbow copper x BSP parallel female thread	15mm x 1/2"	10	240	901825
	22mm x 3/4"	10	90	901826
				

	Size	Pk 1	Pk 2	Code
MEF15 Backplate elbow. Copper x BSP parallel female thread. Backplate with three hole fixing	15mm x 1/2"	10	120	901827
				
MEF21 Obtuse elbow, 45° copper x copper	15mm	10	300	901842
	22mm	10	100	901843
	28mm	10	60	901844
	35mm	1	15	901845
	42mm	1	10	901846
54mm	1	10	901847	
				
MEF21S Obtuse street elbow, 45° female copper x male copper for insertion in fitting	15mm	10	300	901848
	22mm	10	100	901849
	28mm	10	60	901850
	35mm	1	15	901851
	42mm	1	10	901852
				
MEF22 Partial crossover female copper x male copper for insertion in fitting	15mm	5	100	901853
	22mm	5	60	901854
				
MEF23 Full crossover copper x copper	15mm	5	100	901855
	22mm	5	40	901856
				
MEF24 Equal tee, all ends for copper	8mm	10	500	901857
	10mm	10	350	901858
	15mm	10	150	901859
	22mm	10	80	901860
	28mm	10	40	901861
	35mm	1	15	901862
	42mm	1	10	901863
	54mm	1	5	901864
				
MEF25 Tee, reduced branch, all ends for copper	15 x 15 x 10mm	10	150	901865
	22 x 22 x 15mm	10	80	901866
	28 x 28 x 15mm	10	40	901867
	28 x 28 x 22mm	10	40	901868
	35 x 35 x 15mm	1	15	901869
	35 x 35 x 22mm	1	15	901870
	35 x 35 x 28mm	1	15	901871
	42 x 42 x 15mm	1	10	901872
	42 x 42 x 22mm	1	10	901873
	42 x 42 x 28mm	1	10	901874
	42 x 42 x 35mm	1	10	901875
	54 x 54 x 15mm	1	10	901876
	54 x 54 x 22mm	1	10	901877
	54 x 54 x 28mm	1	10	901878
	54 x 54 x 35mm	1	10	901879
54 x 54 x 42mm	1	10	901880	
				
MEF26 Tee, one end reduced, all ends for copper	22 x 15 x 22mm	10	80	901881
	28 x 15 x 28mm	10	40	901882
	28 x 22 x 28mm	10	40	901883
	35 x 22 x 35mm	1	15	901884
	35 x 28 x 35mm	1	15	901885
				

	Size	Pk 1	Pk 2	Code
 <p>MEF27 Tee, one end and branch reduced, all ends for copper</p>	22 x 15 x 15mm	10	80	901886
	28 x 15 x 15mm	10	40	901887
	28 x 15 x 22mm	10	40	901888
	28 x 22 x 15mm	10	40	901889
	28 x 22 x 22mm	10	40	901890
	35 x 28 x 15mm	1	15	901891
	35 x 28 x 28mm	1	15	901892
	42 x 35 x 35mm	1	10	901893
	54 x 42 x 42mm	1	5	901894
 <p>MEF28 Tee, both ends reduced, all ends for copper</p>	15 x 15 x 22mm	10	80	901895
 <p>MEF61 Stop end for use with copper tube</p>	8mm	10	800	901920
	10mm	10	800	901921
	15mm	10	350	901922
	22mm	10	250	901923
	28mm	10	150	901924
	35mm	10	70	901925
	42mm	1	25	901926
	54mm	1	20	901927
 <p>MEF61AV Air release stop end. Female end for use on copper tube</p>	15mm	10	300	901928
 <p>MEF62 Straight tap connector copper x BSP hexagonal union nut. Spigot and washer joint</p>	15mm x 1/2"	10	160	901929
	15mm x 3/4"	10	100	901930
	22mm x 3/4"	10	80	901931
 <p>MEF63 Bent tap connector copper x BSP hexagonal union nut. Spigot and washer joint</p>	15mm x 1/2"	10	120	901932
	15mm x 3/4"	10	80	901933
	22mm x 3/4"	10	80	901934
 <p>MEF64 Bent union adaptor copper x BSP union nut. Cone joint to BS 1010. Supplied with bent copper tail</p>	22mm x 1"	10	40	901935
 <p>MEF68 Straight union adaptor copper x BSP union nut. Cone joint to BS 1010</p>	22mm x 1"	10	40	901936
	28mm x 1 1/4"	10	60	901937



	Size	Pk 1	Pk 2	Code
--	------	------	------	------



















Compression Fittings



K600 BRASS COMPRESSION FITTINGS

- Non-manipulative (type A) duplex brass compression fittings in sizes from 8-54mm
- Suitable for use on closed circuit central heating systems, in above ground hot and cold water services, on compressed air lines and other fluids and low pressure gas services
- WRAS approved.
- Manufactured to BS EN 1254 Part 2

 <p>MC301 Straight coupling copper x copper</p>	8mm	5	200	903009
	10mm	5	250	903010
	15mm	5	150	903012
	22mm	5	80	903016
	28mm	5	50	903018
	35mm	1	25	903020
	42mm	1	15	903021
	54mm	1	10	903022
	10 x 8mm	5	250	903011
	15 x 8mm	5	150	903013
	15 x 10mm	5	150	903014
	15 x 12mm	5	150	903015
	22 x 15mm	5	100	903017
	28 x 22mm	5	50	903019
 <p>MC301BP Burst repair coupling copper x copper</p>	15 x 15 x 80mm	5	75	903106
 <p>MC302 Male coupling copper x BSP parallel male thread</p>	8 x 1/4"	5	300	903038
	10 x 1/4"	5	300	903039
	10 x 3/8"	5	250	903040
	10 x 1/2"	5	150	903041
	22 x 1/2"	5	100	903042
	22 x 3/4"	5	90	903043
	15 x 1/4"	5	150	903044
	22 x 1"	5	70	903045
	28 x 3/4"	5	50	903046
	15 x 3/8"	5	150	903047
	28 x 1"	5	50	903048
	15 x 1/2"	5	150	903049
	28 x 1.1/4"	5	40	903050
	35 x 1"	1	30	903051
15 x 3/4"	5	100	903052	
35 x 1.1/4"	1	25	903053	
42 x 1.1/2"	1	15	903054	
54 x 2"	1	12	903055	
 <p>MC303 Female coupling copper x BSP parallel female thread</p>	8mm x 1/4"	5	300	903023
	10mm x 1/4"	5	200	903024
	10mm x 3/8"	5	200	903025
	10mm x 1/2"	5	150	903026
	15mm x 1/4"	5	150	903027
	15mm x 3/8"	5	150	903028
	15mm x 1/2"	5	150	903029
	15mm x 3/4"	5	100	903030
	22mm x 1/2"	5	100	903031
	22mm x 3/4"	5	90	903032
	22mm x 1"	5	75	903033
	28mm x 1"	5	50	903034
	35mm x 1.1/4"	1	25	903035
	42mm x 1.1/2"	1	25	903036
54mm x 2"	1	12	903037	

	Size	Pk 1	Pk 2	Code	
	MC401 Elbow copper x copper	8mm	5	400	903061
	10mm	5	200	903062	
	15mm	5	125	903063	
	22mm	5	60	903064	
	28mm	5	40	903065	
	35mm	1	20	903066	
	42mm	1	15	903067	
	54mm	1	8	903068	
	MC402 Male elbow copper x BSP parallel male thread	15mm x 1/2"	5	120	903069
	22mm x 3/4"	5	70	903070	
	22mm x 1"	5	40	903071	
	28mm x 1"	5	30	903072	
	35mm x 1.1/4"	1	20	903073	
	42mm x 1.1/2"	1	12	903074	
	54mm x 2"	1	8	903075	
	MC403 Female elbow copper x BSP parallel female thread	15mm x 1/2"	5	120	903076
	15mm x 3/4"	5	60	903077	
	22mm x 3/4"	5	65	903078	
	22mm x 1"	5	45	903079	
	28mm x 3/4"	5	40	903084	
	28mm x 1"	5	40	903080	
	35mm x 1.1/4"	1	20	903081	
	42mm x 1.1/2"	1	12	903082	
	54mm x 2"	1	9	903083	
		MC403W Backplate elbow copper x BSP parallel female thread with backplate	15mm x 1/2"	5	60
22mm x 3/4"		5	30	903105	
	MC601EQ Equal tee, all ends for copper	10mm	5	100	903085
	15mm	5	75	903086	
	22mm	5	40	903087	
	28mm	5	25	903088	
	35mm	1	12	903089	
	42mm	1	10	903090	
	54mm	1	5	903091	
		MC601 Tee both ends reduced	15 x 15 22mm	5	60
	MC601 Tee, one end reduced, all ends for copper	22 x 15 x 22mm	5	50	903093
	28 x 15 x 28mm	5	30	903094	
	28 x 22 x 28mm	1	25	903095	
	MC601 Tee, with reduced branch, all ends for copper	22 x 15mm	5	50	903096
	28 x 15mm	5	20	903097	
	28 x 22mm	5	20	903098	
	MC601 Tee, one end and branch reduced, all ends for copper	22 x 15 x 15mm	5	60	903099

	Size	Pk 1	Pk 2	Code	
	MC303SF Straight swivel tap connector, copper x union nut, Spigot and fibre washer joint	15mm x 1/2"	5	100	903056
	15mm x 3/4"	5	100	903057	
	22mm x 3/4"	5	65	903058	
	MC403SF Bent swivel tap connector, copper x union nut, Spigot and fibre washer joint	15mm x 1/2"	5	100	903059
	22mm x 3/4"	5	60	903060	
	MC684 Tee CxF end	15mm x 1/2"	5	70	903100
	MC617 Tee CxF branch	15mm x 1/2"	5	75	903101
	22mm x 1/2"	5	45	903102	
	22mm x 3/4"	5	40	903103	
	MC68 Reducing set for reducing the size of a Kuterlite socket. N.B. Only one reducing set can be used per end	10 x 8mm	5	150	903107
	15 x 8mm	5	150	903108	
	15 x 10mm	5	150	903109	
	15 x 12mm	5	150	903110	
	22 x 15mm	5	100	903111	
	28 x 15mm	5	100	903112	
	28 x 22mm	5	100	903113	
	MC321 Tank connector copper end with flange and backnut	15mm	5	100	903000
	22mm	5	70	903001	
	28mm	5	30	903002	
	35mm	1	25	903003	
	42mm	1	12	903004	
	54mm	1	12	903005	
	MC323 End Stop end. Body may be removed at any time and another Kuterlite fitting used with the same nut and compression ring	15mm	5	200	903006
	22mm	5	150	903007	
	28mm	5	80	903008	
	MC63B Blanking discs	15mm	5	750	903114
	22mm	5	600	903115	
	28mm	5	200	903116	

	Size	Pk 1	Pk 2	Code
 MC63C Copper cones	8mm	10	2500	903117
	10mm	10	1000	903118
	15mm	50	1000	903119
	22mm	10	800	903120
	28mm	5	350	903121
	3/4" imperial	10	800	903122
 MC63B Brass cones	8mm	10	2500	903123
	10mm	10	1000	903124
	15mm	10	1000	903126
	22mm	10	800	903127
	28mm	5	350	903128

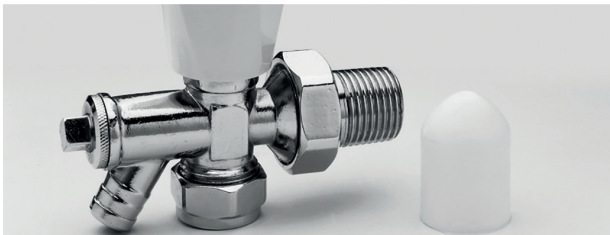

Manual and Drain Off Radiator Valves





- Suitable for sealed systems (10 bar rated) - tested in accordance with BS2767-10
- White handles as standard - LS cap included
- Comprehensive range: 10-15mm includes drain off variant
- Chrome plated

 Jazz manual radiator valve	15mm	10	80	647201
 Jazz drain off radiator valve	15mm	10	60	647203
 Jazz angle radiator valves	10mm 15mm	10 10	80 80	647054 647055
 Drain off angle radiator valves	10mm 15mm	10 10	60 60	647057 647058



Push-fit Radiator Valves

- Suitable for PE-X polybutylene, multi-layer pipes (to BS7291: Part 1, 2, and 3) and copper pipe (to BS2871: Part 1)
(NB: Plastic pipes to BS7291 should be used)
- High quality polished chrome finish
- Security clip option to prevent accidental removal of pipe
- 10mm and 15mm straight and elbow adaptors available

 Manual radiator valve with straight push-fit connections	10mm 15mm	10 10	0 0	663003 663004
 Manual radiator valve with elbow push-fit connections	10mm 15mm	10 10	0 0	663001 663002
 Drain off radiator valves with straight push-fit connections	10mm 15mm	10 10	0 0	663007 663008
 Drain off radiator valves with elbow push-fit connections	10mm 15mm	10 10	0 0	663005 663006
 Manual straight radiator valve with push-fit connector	10mm	10	0	647081





Servicing Valves, Filling Loop







- Compact design
- Chrome plated
- Quality, durability and economy

	Size	Pk 1	Pk 2	Code
M720 straight service valve	15mm x 15mm	25	0	570012
				
M722 straight service valve with tap connection	15mm x 1/2"	25	0	570011
				
Double check valve - DZR	15mm x 15mm	20	0	570001
				
Filling loop with tee	15mm x 15mm	1	0	570002
				





Thermostatic and Manual Radiator Valves

Thermostatic radiator valve with standard tail	10mm 15mm	1 1	10 10	42251 42250
				
TRV and lockshield pack with standard tail	10mm 15mm	1 1	10 10	42253 42252
				

	Size	Pk 1	Pk 2	Code
Thermostatic radiator valve with self sealing tail	10mm 15mm	1 1	10 10	42261 42260
				
TRV and lockshield pack with self sealing tail	10mm 15mm	1 1	10 10	42263 42262
				
TRV and lockshield pack with drain off	10mm 15mm	1 1	10 10	42255 42254
				
Manual radiator valve with standard tail	8mm 10mm 15mm	1 1 1	10 10 10	42150 42151 42152
				
Manual radiator valve with standard tail	15mm	1	10	42148
				
Manual radiator valve with self sealing tail	15mm	1	10	42092
				
Manual radiator valve with standard tail	8mm 10mm 15mm	1 1 1	10 10 10	42153 42154 42155
				

Accessories

Reducer	15 x 8mm	1	0	42271
				
Self sealing tail	n/a	1	0	42272
				
Locking and limiting pin	n/a	25	0	42270
				



CERTIFICATION MARK

This certifies that

PEGLER YORKSHIRE GROUP LTD

has had the undermentioned product examined, tested and found, when correctly installed, to comply with the requirements of the United Kingdom Water Supply (Water Fittings) Regulations and Scottish Water Byelaws.

MERCIA 'W' RANGE OF COPPER, DZR BRASS OR GUNMETAL CAPILLARY, LEAD FREE SOLDER RING AND THREADED FITTINGS FOR USE WITH COPPER PIPE

The certificate by itself is not evidence of a valid WRAS Approval. Confirmation of the current status of an approval must be obtained from the WRAS Directory (www.wras.co.uk/directory)

The product so mentioned will be valid until the end of:

September 2020

1509087

Certificate No.

Handwritten signature of J. Furnival in black ink.

Secretary

Handwritten signature of K. Leisby in black ink.

Chairman, Product Assessment Group

October 2014



CERTIFICATION MARK

This certifies that

PEGLER YORKSHIRE GROUP LTD

has had the undermentioned product examined, tested and found, when correctly installed, to comply with the requirements of the United Kingdom Water Supply (Water Fittings) Regulations and Scottish Water Byelaws.

MERCIA "E" RANGE OF END FEED FITTINGS FOR USE WITH COPPER PIPE

The certificate by itself is not evidence of a valid WRAS Approval. Confirmation of the current status of an approval must be obtained from the WRAS Directory (www.wras.co.uk/directory)

The product so mentioned will be valid until the end of:

December 2016

1112116

Certificate No.

Handwritten signature of J. Furnival in black ink.

Secretary

Handwritten signature of K. Leisby in black ink.

Chairman, Product Assessment Group

October 2014