

FITTINGS PLASTIC PUSH-IN FITTINGS

Specification

Applicable Fluid Type	Air (no other type of gas or liquid)
Working Pressure Range	0-150PSI / 0-9.9Kgf/cm ² (0-990KPa)
Negative Pressure	-29.5in Hg / -750mmHg (-750Torr)
Working Temperature Range	32°F - 140°F / 0°C - 60°C

Product Features

1. One-touch push-to-connect configuration allows an instant tubing connection
2. All fittings are useful for piping in confined spaces, given its six-angle wrench processing inside
3. Immediate strong engineering plastic (POM) sleeve disconnection by pressing the sleeve and then simply removing the tube from the fitting
4. Fittings are equipped with Teflon-treatment already or o-ring on the thread
5. Nickel-plated brass body ensures anti-contamination properties for an extended product life



FITTINGS MANUAL FLOW CONTROL RESTRICTORS

Specification

Applicable Fluid Type	Air (no other type of gas or liquid)
Working Pressure Range	0-150PSI / 0-9.9Kgf/cm ² (0-990KPa)
Negative Pressure	-29.5in Hg / -750mmHg (-750Torr)
Working Temperature Range	32°F - 140°F / 0°C - 60°C

Product Features

1. Accurate regulation of an optimal airflow rate for precise motion control
2. Compact design provides the comparable range of speed as larger ones
3. Control-out and control-in types are available for all models
4. All BSP, NPT and metric threads are sealant pre-coated



Application

1. A valve controls the speed of the air pressure actuator
2. Mainly installed for the movement of machines such as cylinder, air actuator, etc

MALE STUDS

Male Thread, Metric & BSPT

PART NO	D	D1	R	A	B	C	H
2019-4890	4	10	M5x0.8	4	21.5	16	10
2046-7163	4	10	M6x1	5	22.5	16	10
2019-4932	4	10	R1/8	7.5	21	16	10
2019-4940	4	10	R1/4	9	20	16	14
2046-7164	4	10	R3/8	11	24	16	17
2019-4957	6	10	M5x0.8	4	24	17	12
2046-7165	6	12.8	M6x1	5	25	17	12
2019-4965	6	12.8	R1/8	7.5	22	17	12
2019-4973	6	12.8	R1/4	9	21	17	14
2019-4981	6	12.8	R3/8	11	23	17	17
2046-7166	6	12.8	R1/2	13	25.5	17	21
2019-4999	8	12.8	R1/8	7.5	27	18	14
2019-5004	8	13.8	R1/4	9	24	18	14
2019-5012	8	13.8	R3/8	11	24.5	18	17
2019-5020	8	13.8	R1/2	13	26	18	21
2019-5038	10	16.8	R1/8	7.5	28	19.3	17
2019-5046	10	16.8	R1/4	9	29	19.3	17
2019-5053	10	16.8	R3/8	11	27	19.3	17
2019-5061	10	16.8	R1/2	13	26	19.3	21
2019-5076	12	19.8	R1/4	9	33	21	19
2019-5087	12	19.8	R3/8	11	29.5	21	19
2019-5095	12	19.8	R1/2	13	27.5	21	21

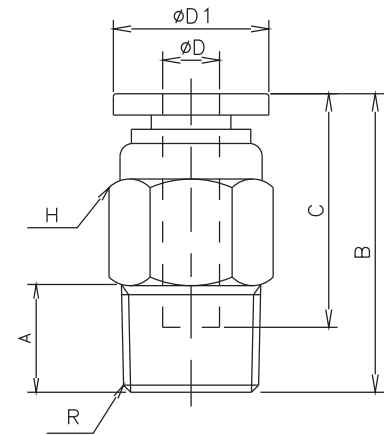

Male Thread, BSPP

PART NO	D	P	R	A	B	C	H1	H2
2028-7736	4	10	G1/8	5.5	20	16	12	2.5
2028-7793	4	10	G1/4	6	19	16	14	2.5
2028-7819	6	12.8	G1/8	5.5	24	17	12	4
2028-7843	6	12.8	G1/4	6	21	17	14	4
2028-7868	6	12.8	G3/8	6.5	21	17	17	4
2028-7876	8	13.8	G1/8	5.5	25.5	18	14	4
2028-7884	8	13.8	G1/4	6	22	18	14	6
2028-7900	8	13.8	G3/8	6.5	21	18	17	6.5
2028-7918	8	13.8	G1/2	8	22.5	18	19	6
2028-7926	10	16.8	G1/8	5.5	27.8	19.3	17	4
2028-7934	10	16.8	G1/4	6	27.8	19.3	17	6
2028-7942	10	16.8	G3/8	6.5	25.8	19.3	19	8
2028-7959	10	16.8	G1/2	8	26.3	19.3	21	8
2028-7967	12	19.8	G1/4	6	30	21	19	8
2028-7975	12	19.8	G3/8	6.5	26.5	21	19	8
2028-7983	12	19.8	G1/2	8	28	21	21	8

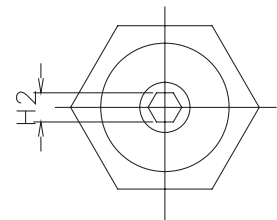
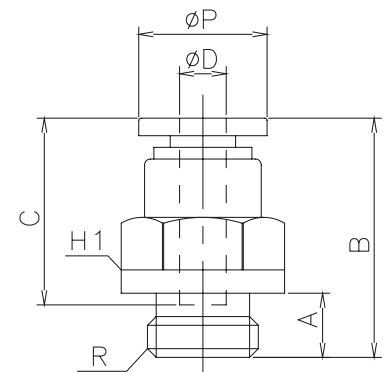

FEMALE STUDS

Female Thread, BSPP

PART NO	D	R	P	A	B	C	H	G
2019-6325	4	G1/8	11	7	24	16	14	9
2046-7167	4	G1/4	11	7.5	26.5	16	17	9
2019-6366	6	G1/8	13	7	27	17	14	8.5
2019-6416	6	G1/4	13	7.5	26	17	17	9.5
2019-6432	6	G3/8	13	8	28.5	17	19	10
2019-6440	8	G1/8	15	7	28	18	17	11
2019-6465	8	G1/4	15	7.5	28	18	17	12
2019-6721	8	G3/8	15	8	28.5	18	19	14
2046-7168	8	G1/2	15	10	31	18	24	16
2019-6739	10	G1/8	17	7	29.5	19.3	19	11
2019-6754	10	G1/4	17	7.5	29.5	19.3	19	12
2019-6911	10	G3/8	17	8	32	19.3	21	14
2046-7169	10	G1/2	17	10	32	19.3	24	16
2019-6929	12	G1/4	20	7.5	31.5	21	21	12
2019-7018	12	G3/8	20	8	33	21	21	14
2019-7059	12	G1/2	20	10	33	21	24	16

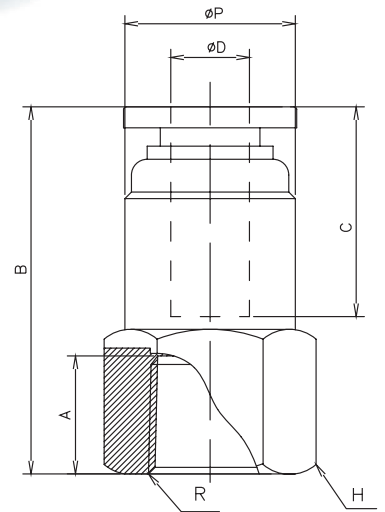

FEMALE BULKHEAD CONNECTORS

Female Thread, Metric & BSPP

PART NO	D	D1	R	A	B	C	G	H1	H2	M
2046-7194	4	10	M5x0.8	5	22	16	7	14	14	M12X1
2019-7083	4	10	R1/8	9	26.5	16	11	14	14	M12X1
2046-7196	4	10	R1/4	10	28.5	16	12	17	14	M12X1
2046-7197	6	12.8	M5x0.8	5	23	17	7	14	17	M14X1
2046-7198	6	12.8	M6x1	6	24	17	8	14	17	M14X1
2019-7125	6	12.8	R1/8	9	27.5	17	11	17	17	M14X1
2019-7133	6	12.8	R1/4	10	29	17	12	17	17	M14X1
2046-7199	6	12.8	R3/8	12	31	17	14	19	17	M14X1
2046-7200	6	12.8	R1/2	14	34	17	16	24	17	M14X1
2046-7201	8	13.8	R1/8	9	28	18	11	17	19	M16X1
2019-7166	8	13.8	R1/4	10	29	18	12	17	19	M16X1
2019-7182	8	13.8	R3/8	12	31.5	18	14	19	19	M16X1
2046-7202	8	13.8	R1/2	14	35	18	16	24	19	M16X1
2046-7203	10	16.8	R1/8	9	29.3	19.3	11	21	24	M20X1
2019-7299	10	16.8	R1/4	10	34.8	19.3	12	21	24	M20X1
2019-7307	10	16.8	R3/8	12	33.3	19.3	14	21	24	M20X1
2046-7204	10	16.8	R1/2	14	35.3	19.3	16	24	24	M20X1
2019-7315	12	19.8	R1/4	10	33.5	21	12	21	26	M22X1
2019-7497	12	19.8	R3/8	12	36	21	14	21	26	M22X1
2046-7205	12	19.8	R1/2	14	38	21	16	24	26	M22X1

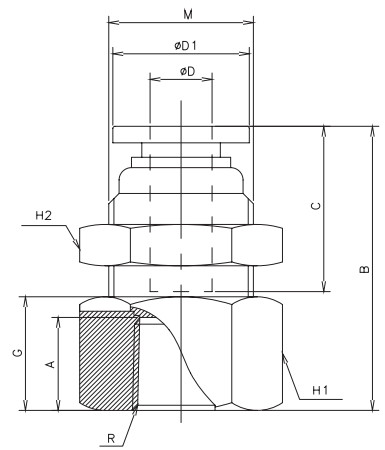

MALE STUD SWIVEL ELBOWS

Male Thread, Metric & BSPT

PART NO	D	D1	R	A	B	C	E	F	H	d
2019-5103	4	10	M5x0.8	4	25	15.5	17.5	8	10	3.2
2046-7170	4	10	M6x1	5	26	15.5	17.5	8	12	3.2
2019-5111	4	10	R1/8	7.5	25	15.5	17.5	8	10	3.2
2019-5129	4	10	R1/4	9	26.5	15.5	17.5	8	14	3.2
2019-5822	6	12.8	M5x0.8	4	27.5	15.6	20.5	9.5	12	3.2
2046-7171	6	12.8	M6x1	5	28.5	15.6	20.5	9.5	12	3.2
2019-5145	6	12.8	R1/8	7.5	27.5	15.6	20.5	9.5	12	3.2
2019-5152	6	12.8	R1/4	9	29	15.6	20.5	9.5	14	3.2
2019-5160	6	12.8	R3/8	11	31.5	15.6	20.5	9.5	17	3.2
2046-7172	6	12.8	R1/2	13	34	15.6	20.5	9.5	21	3.2
2019-5178	8	13.8	R1/8	7.5	29.5	18	22.5	10.2	14	3.2
2019-5186	8	13.8	R1/4	9	31	18	22.5	10.2	14	3.2
2019-5194	8	13.8	R3/8	11	33.5	18	22.5	10.2	17	3.2
2019-5202	8	13.8	R1/2	13	36	19	22.5	10.2	21	3.2
2019-5210	10	16.8	R1/8	7.5	33.2	19.3	26.3	13	17	3.2
2019-5228	10	16.8	R1/4	9	34.7	19.3	26.3	13	17	3.2
2019-5236	10	16.8	R3/8	11	36.7	19.3	26.3	13	17	3.2
2019-5244	10	16.8	R1/2	13	39.2	19.3	26.3	13	21	3.2
2019-5251	12	19.8	R1/4	9	35.5	21	27.8	13	19	3.2
2019-5269	12	19.8	R3/8	11	38	21	27.8	13	19	3.2

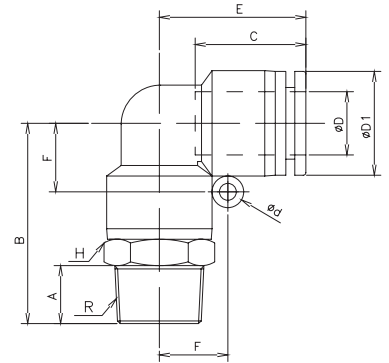

Male Thread, BSPP

PART NO	D	P	R	A	B	C	E	F	H1	H2
2028-8221	4	10	G1/8	5.5	24.1	15.5	17.5	8	12	3.2
2028-8239	4	10	G1/4	6	24.7	15.5	17.5	8	14	3.2
2028-8247	6	12.8	G1/8	5.5	27	15.6	20.5	9.5	12	3.2
2028-8254	6	12.8	G1/4	6	27.5	15.6	20.5	9.5	14	3.2
2028-8262	6	12.8	G3/8	6.5	29	15.6	20.5	9.5	17	3.2
2028-8270	8	13.8	G1/8	5.5	29.2	18	22.5	10.2	14	3.2
2028-8288	8	13.8	G1/4	6	29.2	18	22.5	10.2	14	3.2
2028-8296	8	13.8	G3/8	6.5	30	18	22.5	10.2	17	3.2
2028-8304	8	13.8	G1/2	8	31.7	18	22.5	10.2	21	3.2
2028-8312	10	16.8	G1/8	5.5	33.7	19.3	26.3	13	17	3.2
2028-8320	10	16.8	G1/4	6	34.2	19.3	26.3	13	17	3.2
2028-8338	10	16.8	G3/8	6.5	34.2	19.3	26.3	13	17	3.2
2028-8379	10	16.8	G1/2	8	35.2	19.3	26.3	13	21	3.2
2028-8403	12	19.8	G1/4	6	35	21	27.8	13	19	3.2
2028-8411	12	19.8	G3/8	6.5	34.5	21	27.8	13	19	3.2
2028-8429	12	19.8	G1/2	8	36	21	27.8	13	21	3.2

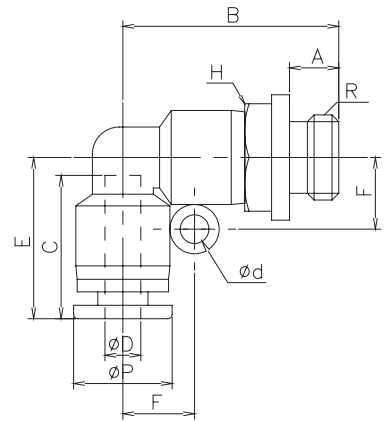

MALE STUD SWIVEL ELBOWS

Extended Male Thread, Metric & BSPT

PART NO	D	D1	R	A	B	C	E	F	H	d
2019-5905	4	10	M5x0.8	4	35.5	15.5	17.5	8	10	3.2
2019-5913	4	10	R1/8	7.5	35.5	15.5	17.5	8	10	3.2
2019-5939	6	12.8	M5x0.8	4	40.5	15.6	20.5	9.5	12	3.2
2046-7191	6	12.8	M6x1	5	41.5	15.6	20.5	9.5	12	3.2
2019-5947	6	12.8	R1/8	7.5	40.5	15.6	20.5	9.5	12	3.2
2019-5954	6	12.8	R1/4	9	43.5	15.6	20.5	9.5	14	3.2
2019-5970	8	13.8	R1/8	7.5	44	18	22.5	10.2	14	3.2
2019-5988	8	13.8	R1/4	9	45.5	18	22.5	10.2	14	3.2
2019-6135	10	16.8	R1/8	7.5	51.2	19.3	26.3	13	17	3.2
2019-6150	10	16.8	R1/4	9	52.7	19.3	26.3	13	17	3.2
2019-6192	12	19.8	R1/4	9	55.5	21	27.8	13	19	3.2
2019-6220	12	19.8	R3/8	11	58	21	27.8	13	19	3.2

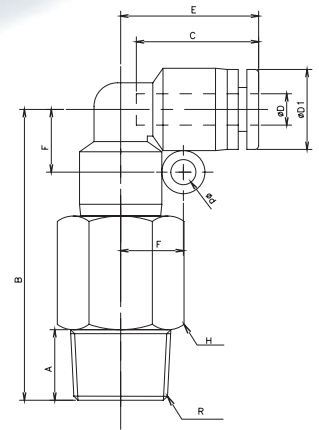

Extended Male Thread, BSPP

PART NO	D	D1	R	A	B	C	E	F	H1	d
2033-8729	4	10	G1/8	5.5	34.5	15.5	17.5	8	14	3.2
2033-8737	4	10	G1/4	6	35	15.5	17.5	8	17	3.2
2033-8745	6	12.8	G1/8	5.5	40	15.6	20.5	9.5	14	3.2
2033-8752	6	12.8	G1/4	6	42	15.6	20.5	9.5	17	3.2
2033-8778	6	12.8	G3/8	6.5	43.5	15.6	20.5	9.5	21	3.2
2033-8786	8	13.8	G1/8	5.5	44	18	22.5	10.2	14	3.2
2033-9107	8	13.8	G1/4	6	44	18	22.5	10.2	14	3.2
2033-9115	8	13.8	G3/8	6.5	45.5	18	22.5	10.2	17	3.2
2033-9131	10	16.8	G1/8	5.5	51.7	19.3	26.3	13	17	3.2
2033-9149	10	16.8	G1/4	6	52.2	19.3	26.3	13	17	3.2
2033-9156	10	16.8	G3/8	6.5	52.2	19.3	26.3	13	21	3.2
2033-9180	12	19.8	G3/8	6.5	54.5	21	27.8	13	21	3.2

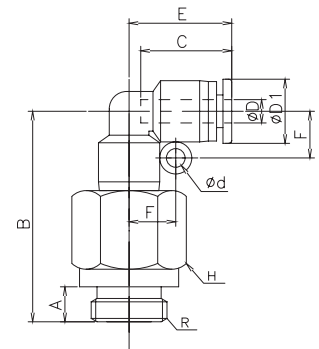

MALE CENTRE LEG, SWIVEL TEES

Male Thread, Metric & BSPT

PART NO	D	R	P	A	B	C	E	F	H	d
2019-5293	4	M5x0.8	10	4	25	15.5	17.5	8	10	3.2
2019-5301	4	R1/8	10	7.5	25	15.5	17.5	8	10	3.2
2019-5335	4	R1/4	10	9	26.5	15.5	17.5	8	14	3.2
2019-5541	6	M5x0.8	12.8	4	27.5	15.6	19.5	9.5	12	3.2
2019-5749	6	R1/8	12.8	7.5	27.5	15.6	19.5	9.5	12	3.2
2019-5764	6	R1/4	12.8	9	29	15.6	19.5	9.5	14	3.2
2019-5772	6	R3/8	12.8	11	31.5	15.6	19.5	9.5	17	3.2
2046-7175	6	R1/2	12.8	13	34	15.6	19.5	9.5	21	3.2
2019-5780	8	R1/8	13.8	7.5	29.5	18	23	9.5	14	3.2
2019-5798	8	R1/4	13.8	9	31	18	23	10.2	14	3.2
2019-5806	8	R3/8	13.8	11	33.5	18	23	10.2	17	3.2
2019-5814	8	R1/2	16.8	13	36	18	23	10.2	21	3.2
2019-5830	10	R1/8	16.8	7.5	33.2	19.3	26.3	10.2	17	3.2
2019-5848	10	R1/4	16.8	9	34.7	19.3	26.3	13	17	3.2
2019-5855	10	R3/8	16.8	11	36.7	19.3	26.3	13	17	3.2
2019-5863	10	R1/2	19.8	13	39.2	19.3	26.3	13	21	3.2
2019-5871	12	R1/4	19.8	9	35.5	21	27.5	13	19	3.2
2019-5889	12	R3/8	19.8	11	38	21	27.5	13	19	3.2
2019-5897	12	R1/2	19.8	13	40	21	27.5	13	21	3.2

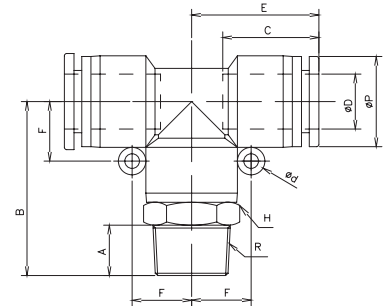

Male Thread, BSPP

PART NO	D	R	P	A	B	C	E	F	H	d
2028-8007	4	G1/8	10.5	5.5	23.6	15.5	17.5	8	12	3.2
2028-8023	4	G1/4	10.5	6	24	15.5	17.5	8	14	3.2
2028-8031	6	G1/8	13	5.5	27	15.6	19.8	9.5	12	3.2
2028-8049	6	G1/4	13	6	27.5	15.6	19.8	9.5	14	3.2
2028-8056	6	G3/8	13	6.5	29	15.6	19.8	9.5	17	3.2
2028-8064	8	G1/8	14.5	5.5	29.5	18	23	10.2	14	3.2
2028-8072	8	G1/4	14.5	6	29.5	18	23	10.2	14	3.2
2028-8122	8	G3/8	14.5	6.5	31	18	23	10.2	17	3.2
2028-8130	8	G1/2	14.5	8	32	18	23	10.2	21	3.2
2028-8148	10	G1/8	18	5.5	33.7	19.3	26.3	12	17	3.2
2028-8155	10	G1/4	18	6	34.2	19.3	26.3	12	17	3.2
2028-8163	10	G3/8	18	6.5	34.2	19.3	26.3	12	17	3.2
2028-8189	12	G1/4	20	6	35	21	27.5	13	19	3.2
2028-8205	12	G3/8	20	6.5	34.5	21	27.5	13	19	3.2
2028-8213	12	G1/2	20	8	35.5	21	27.5	13	21	3.2

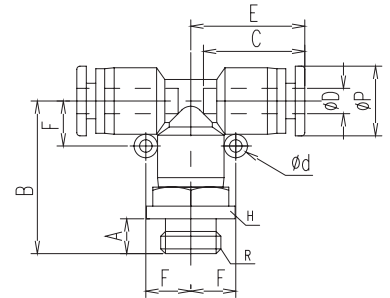

MALE RUN LEG, SWIVEL TEES

Male Thread, Metric & BSPT

PART NO	D	R	P	A	B	C	E	F	H	d
2019-7992	4	M5x0.8	10	4	25	15.5	17.5	8	10	3.2
2019-8008	4	R1/8	10	7.5	25	15.5	17.5	8	10	3.2
2019-8032	6	R1/8	12.8	7.5	27.5	15.6	15.6	9.5	12	3.2
2019-8040	6	R1/4	12.8	9	29	15.6	15.6	9.5	14	3.2
2019-8057	6	R3/8	12.8	11	31.5	15.6	15.6	9.5	17	3.2
2019-8065	8	R1/8	13.8	7.5	29.5	18	18	10.2	14	3.2
2019-8073	8	R1/4	13.8	9	31	18	18	10.2	14	3.2
2019-8081	8	R3/8	13.8	11	33.5	18	18	10.2	17	3.2
2019-8107	10	R1/8	16.8	7.5	33.2	19.3	19.3	13	17	3.2
2019-8115	10	R1/4	16.8	9	34.7	19.3	19.3	13	17	3.2
2019-8123	10	R3/8	16.8	11	36.7	19.3	19.3	13	17	3.2
2019-8164	12	R1/2	19.8	13	40	21	21	13	21	3.2

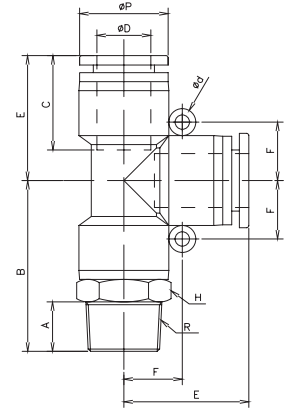

Male Thread, BSPP

PART NO	D	R	P	A	B	C	E	F	H	d
2033-8570	6	G1/8	13	5.5	27	15.6	19.8	9.5	12	3.2
2033-8588	6	G1/4	13	6	27.5	15.6	19.8	9.5	14	3.2
2033-8612	8	G1/4	14.5	6	29.5	18	23	10.2	14	3.2

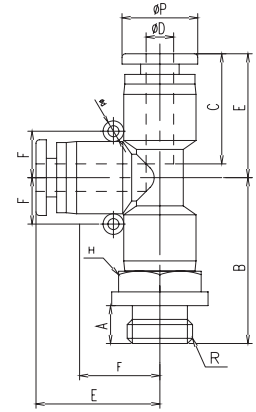

MALE STUD SWIVEL Ys

Male Thread, Metric & BSPT

PART NO	D	R	P	A	B	C	E	F	H	d
2019-7513	4	R1/8	10	7.5	41	15.5	10.5	15	10	3.2
2019-7547	6	R1/8	12.8	7.5	44	15.6	13	15.5	12	3.2
2019-7554	6	R1/4	12.8	9	45.5	15.6	13	15.5	14	3.2
2019-7570	6	R3/8	12.8	11	48	15.6	13	15.5	17	3.2
2019-7596	8	R1/8	13.8	7.5	45.5	18	14.5	15.8	14	3.2
2019-7604	8	R1/4	13.8	9	47	18	14.5	15.8	14	3.2
2019-7612	8	R3/8	13.8	11	48.3	18	14.5	15.8	17	3.2
2019-7620	8	R1/2	13.8	13	50.8	18	14.5	15.8	21	3.2
2019-7638	10	R1/8	16.8	7.5	56.1	19.3	18	20.6	17	4
2019-7646	10	R1/4	16.8	9	57.6	19.3	18	20.6	17	4
2019-7653	10	R3/8	16.8	11	59	19.3	18	20.6	17	4
2019-7950	10	R1/2	16.8	13	61	19.3	18	20.6	21	4
2019-7968	12	R1/4	19.8	9	60.8	21	20	21.3	19	4
2019-7976	12	R3/8	19.8	11	63.3	21	20	21.3	19	4
2019-7984	12	R1/2	19.8	13	65	21	20	21.3	21	4

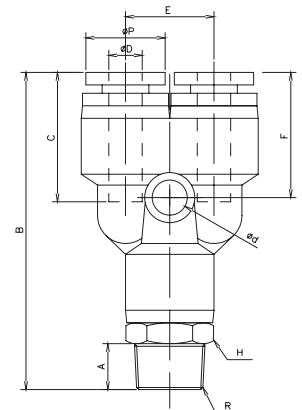

SINGLE BANJOS

Male Thread, Metric & BSPT

PART NO	D	D1	R	A	B	C	E	H	K
2019-8172	4	10	M5x0.8	4	9.2	15.5	19.7	8	10
2046-7183	4	10	M6x1	5	9.2	15.5	19.7	8	10
2019-8180	4	10	R1/8	7.5	12	15.5	21.8	10	14.5
2019-8198	6	12.8	M5x0.8	4	9.2	15.6	22.5	8	10
2046-7185	6	12.8	M6x1	5	9.2	15.6	22.5	8	10
2019-8206	6	12.8	R1/8	7.5	12	15.6	23	10	14.5
2019-8214	6	12.8	R1/4	9	12	15.6	25.5	14	18.2
2046-7186	6	12.8	R3/8	11	15.4	15.6	27.1	19	22
2019-8222	8	13.8	R1/8	7.5	12	18	24.6	10	14.5
2019-8230	8	13.8	R1/4	9	12	18	26.8	14	18.2
2019-8248	8	13.8	R3/8	11	15.4	18	28.8	19	22
2046-7188	10	16.8	R1/4	9	12	19.3	31	14	18.2
2019-8255	10	16.8	R3/8	11	15.4	19.3	31	19	22
2019-8263	10	16.8	R1/2	13	17.5	19.3	34	24	27.4
2046-7189	12	19.8	R1/4	9	12	21	31.8	14	18.2
2019-8271	12	19.8	R3/8	11	15.4	21	34	19	22
2019-8289	12	19.8	R1/2	13	17.5	21	35.8	24	27.4

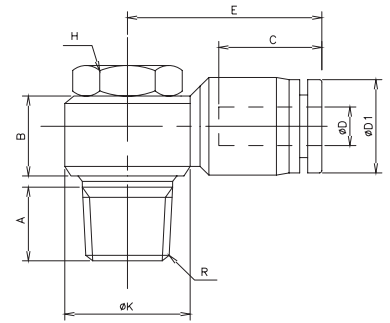

MANUAL FLOW CONTROLLER, UNI-DIRECTIONAL

Elbow, Male Thread, Metric & BSPT

PART NO	D	R	P	A	B	C	E	H	K
2022-9829	4	M5x0.8	10	4	9.2	15.5	19.7	8	10
2022-9845	4	R 1/8	10	7.5	12	15.5	21.8	10	14.5
2022-9860	4	R 1/4	10	9	12	15.5	24	14	18.2
2022-9837	6	M5x0.8	12.8	4	9.2	15.6	22.5	8	10
2046-7181	6	M6x1	12.8	5	9.2	15.6	22.5	8	10
2022-9852	6	R 1/8	12.8	7.5	12	15.6	23	10	14.5
2022-9878	6	R 1/4	12.8	9	12	15.6	25.5	14	18.2
2022-9902	6	R 3/8	12.8	11	15.4	15.6	27.1	19	22
2022-9886	8	R 1/8	13.8	7.5	12	18	24.6	10	14.5
2022-9894	8	R 1/4	13.8	9	12	18	26.8	14	18.2
2022-9910	8	R 3/8	13.8	11	15.4	18	28.8	19	22
2046-7182	8	R 1/2	13.8	13	17.5	18	30.5	24	27.4
2022-9928	10	R 1/4	16.8	9	12	19.3	31	14	18.2
2022-9936	10	R 3/8	16.8	11	15.4	19.3	31	19	22
2022-9969	10	R 1/2	16.8	13	17.5	19.3	34	24	27.4
2022-9944	12	R 1/4	19.8	9	12	21	31.8	14	18.2
2022-9951	12	R 3/8	19.8	11	15.4	21	34	19	22
2022-9977	12	R 1/2	19.8	13	17.5	21	35.8	24	27.4

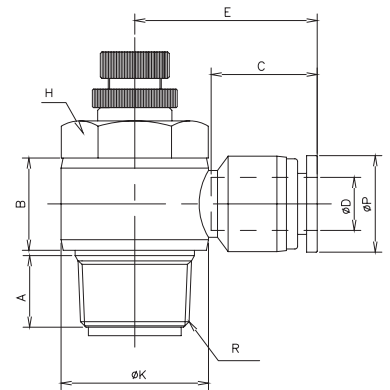

REDUCING MANIFOLDS

Male Thread, BSPT

PART NO	D1	D2	R	P1	P2	A	B	C1	C2	F1	F2	H
2019-9022	6	4	1/8	13	10.5	9	67.7	15.6	15.5	8.8	40.4	11
2019-9048	8	6	1/4	14.5	14.5	11	71.4	18	15.6	8.8	40.4	14
2019-9055	10	8	3/8	18	14.5	13	91.3	20	18	10	47	11

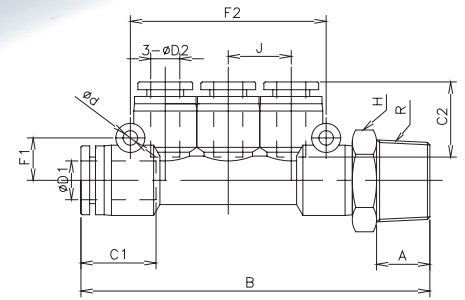

MANUAL SHUT-OFF VALVES

BSPT x BSPT

PART NO	D1	D2	H1	H2	A1	A2	L1	L2	K	d	B1	B2	F
HVSS-02-02	R1/4	R1/4	14	14	9	9	34	34	16.7	4.2	40.3	36.8	16.5
HVSS-03-03	R3/8	R3/8	17	17	11	11	42	42	16.7	4.2	44.5	41	21
HVSS-04-04	R1/2	R3/8	21	21	13	13	44	44	16.7	4.2	44.5	41	21

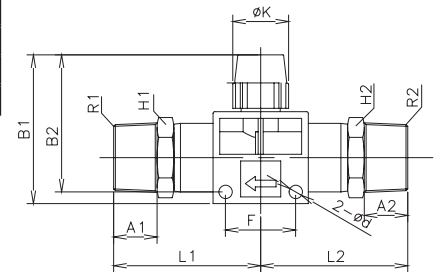

Tube x BSPT

PART NO	D	R	C	E	L	A	H	K	d	B1	B2	F
HVFS6-01	6	R1/8	15.6	25.5	32.5	7.5	14	16.7	4.2	40.3	36.8	16.5
HVFS6-02	6	R1/4	15.6	25.5	34	9	14	16.7	4.2	40.3	36.8	16.5
HVFS8-03	8	R3/8	18	25.8	35.5	11	17	16.7	4.2	40.6	36.8	16.5

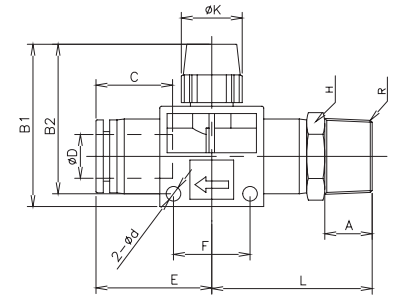

TUBE X TUBE CONNECTORS

Equal Straights

PART NO	D	P	B	C
2019-8297	4	11	31.3	14.5
2019-8305	6	13.2	34.2	15.6
2019-8313	8	14.8	39.5	18
2019-8321	10	18.3	41.9	19.3
209-8339	12	20.4	46.2	21

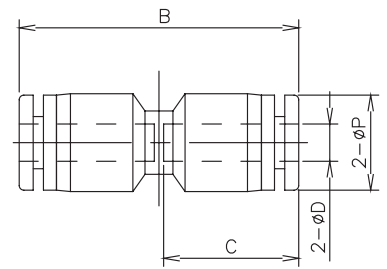

Unequal Straights

PART NO	D	D1	B	C1	C2
2019-8545	6	4	33.1	16	15.5
2019-8552	8	6	38.3	18	15.6
2019-8560	10	8	41.1	19.3	18
2019-8578	12	10	45.3	21	19.3

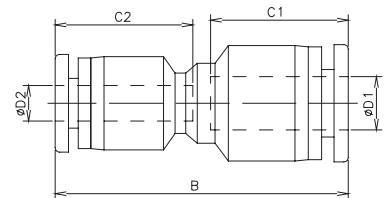

Equal Elbows

PART NO	D	P	C	E	F	d
2019-8347	4	10.3	15.5	17.5	8	3.2
2019-8354	6	12.8	15.6	20.5	9.5	3.2
2019-8362	8	13.8	18	22.8	10.2	3.2
2019-8370	10	17.2	19.3	26.3	13	3.2
2019-8388	12	19.8	21	27.8	13	3.2

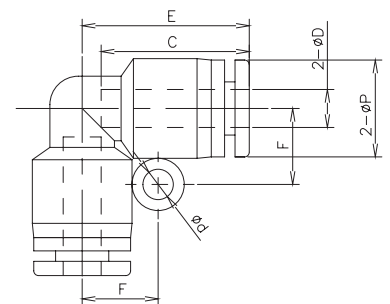

TUBE X TUBE CONNECTORS

Equal Tees

PART NO	D	P	C	E	F	d
2019-8396	4	10.3	15.5	17.5	8	3.2
2019-8404	6	12.6	15.6	20	9.5	3.2
2019-8412	8	13.8	18	23	10.2	3.2
2019-8420	10	17.2	19.3	26.1	13	3.2
2019-8438	12	19.8	21	26.9	13	3.2

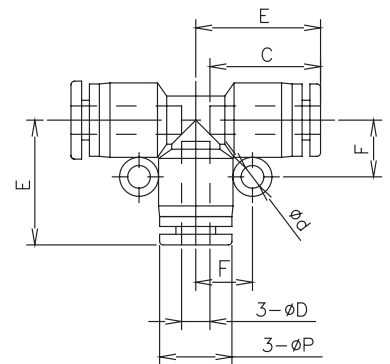

Equal Ys

PART NO	D	D1	E	C	F	d
2019-8446	4	10	10.5	15.5	15	2.8
2019-8453	6	12.8	13	15.6	15.5	2.8
2019-8461	8	13.8	14.5	18	15.8	3.2
2019-8479	10	16.8	18	19.3	20.6	4
2019-8487	12	19.8	20	21	21.3	4

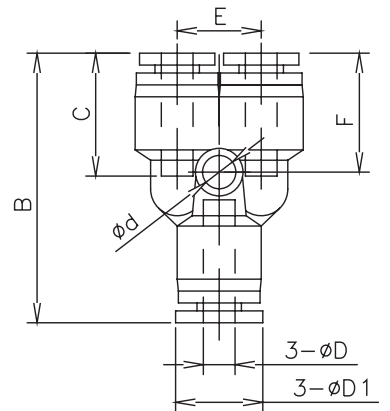

Unequal Ys

PART NO	D	D1	B	C1	C2	E	F	d
2019-9139	6	4	35.5	15.6	15.5	10.5	14.4	2
2019-9162	8	6	41.5	18	15.5	10.5	17	2.7
2019-9170	10	8	49	19.3	18	14.5	19.5	4
2019-9188	12	10	52.3	21	19.3	18	20.3	4

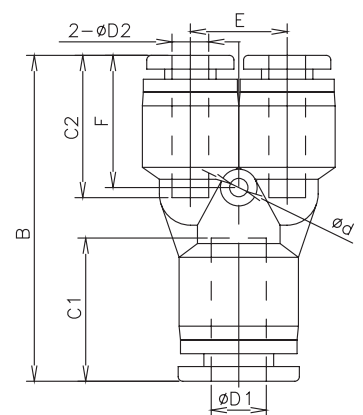

TUBE X TUBE CONNECTORS

Equal Crosses

PART NO	D	D1	E	C	F	d
2019-8974	4	10	17.7	15.5	8	2.2
2019-8982	6	12.8	20.5	15.6	9.5	2.8
2019-8990	8	13.8	22.8	18	10.2	2.8
2019-9006	10	16.8	26.3	19.3	12	4
2019-9014	12	19.8	29.3	21	13	4

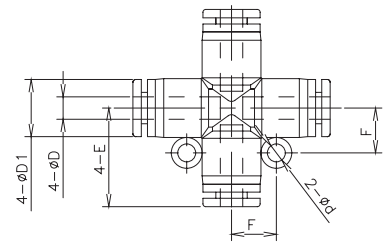

Equal Bulkheads

PART NO	D	P	B	C	H	M
2019-8495	4	10	33.5	16	14	12X1
2019-8503	6	12.8	35	17	17	14X1
2019-8511	8	13.8	40.5	18.5	19	16X1
2019-8529	10	16.8	40	19.3	24	20X1
2019-8537	12	19.8	44.5	21	26	22X1

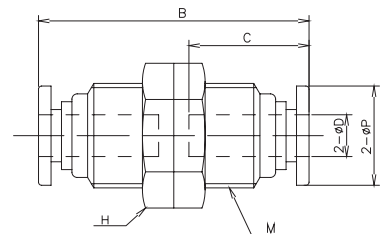

Reducing Manifolds

PART NO	D1	D2	B	C1	C2	J	F1	F2
2019-9063	6	4	60.2	15.6	15.5	13	8.8	40.4
2019-9071	8	4	60.8	18	15.5	13	8.8	40.4
2019-9089	8	6	60.8	18	15.6	13	8.8	40.4
2019-9097	10	6	81	20	15.6	14.5	10	47
2023-0637	10	8	81	20	18	14.5	10	47

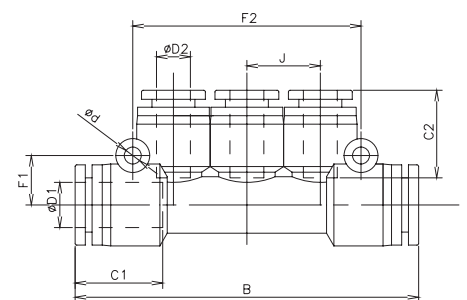

TUBE X STEM CONNECTORS

Straights, Tube x Stem

PART NO	D	D1	B	C	E
2028-8437	6	4	37	15.5	16
2028-8445	8	4	37	15.5	16
2028-8452	8	6	37.5	16	17
2028-8460	10	6	41	16	17
2028-8478	10	8	44	19	18
2028-8486	12	8	43	18	18
2028-8494	12	10	41.8	17.5	19.3

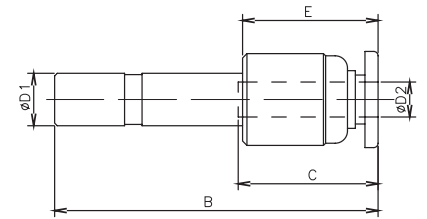

Elbows, Tube x Stem

PART NO	D	B	C	E	F	d
2024-2566	4	31	15.5	17.5	8	3.2
2024-2574	6	38.5	15.6	20.5	9.5	3.2
2024-2582	8	40.5	18	22.5	10.2	3.2
2024-2590	10	46.5	19.3	26.3	13	3.2
2024-2608	12	48	21	27.8	13	3.2

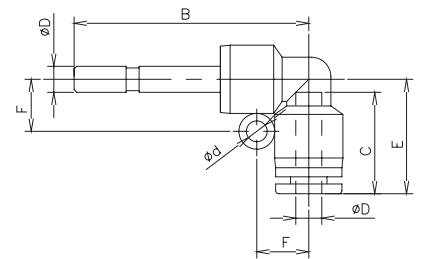

Ys, Tube x Stem

PART NO	D	B	C	E	F	d
2024-2616	4	47.5	15.5	10.5	15	2.8
2024-2624	6	55	15.6	13	15.5	2.8
2024-2632	8	55.3	18	14.5	15.8	3.2
2024-2640	10	70.1	19.3	18	20.6	4
2024-2657	12	73.3	21	20	21.3	4

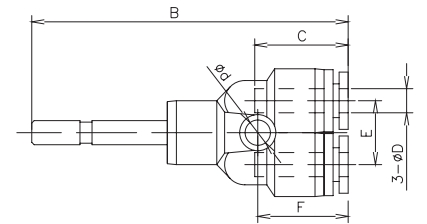

Reducing Ys, Tube x Stem

PART NO	D1	D2	P	B	C	E	F	d
2024-2673	6	4	10.5	52.5	15.5	10.5	14.4	2
2024-2699	8	6	13	55	15.6	13	17.5	2.7
2024-2731	10	8	14.5	58.8	18	14.5	19.5	4

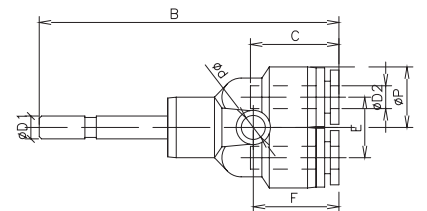

PLUG

Tube

PART NO	D	P1	P2	B	C
2028-8627	4	2	5	30	15.5
2028-8635	6	3	7	34	18
2028-8643	8	4	9	37	18.5
2028-8668	10	5	11	39.5	20.5
2028-8684	12	6	13	44	23

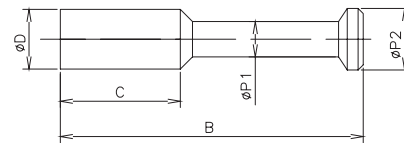

MANUAL SHUT-OFF VALVES

Tube x Tube, Venting

PART NO	D1	D2	C1	C2	E1	E2	K	d	B1	B2	F
HVFF06-06	6	6	15.6	15.6	25.5	25.5	16.7	4.2	40.3	36.8	16.5
HVFF08-06	8	6	18	15.6	25.8	25.5	16.7	4.2	40.3	36.8	16.5
HVFF08-08	8	8	18	18	25.8	25.8	16.7	4.2	40.3	36.8	16.5
HVFF10-10	10	10	19.3	19.3	31.1	31.1	16.7	4.2	44.5	41	21
HVFF12-10	12	10	21	19.3	31.8	31.1	16.7	4.2	44.5	41	21
HVFF12-12	12	12	21	21	31.8	31.8	16.7	4.2	44.5	41	21

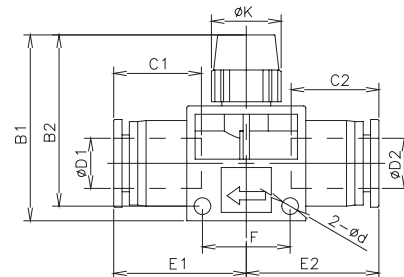

MANUAL FLOW CONTROLLER, UNI-DIRECTIONAL

Straight, Tube x Tube

PART NO	D	D1	B	C	d	F	J	S
2022-9720	4	10	48	15.5	4	8.7	19.4	10.5
2022-9746	6	12.8	49	15.6	4	7.9	19.4	11.1
2022-9753	8	13.8	55.1	18	4	9	21	12
2022-9761	10	16.8	63	20	4	10.1	25	12.2
2022-9779	12	19.8	75	21	4	12.8	31.3	15.6

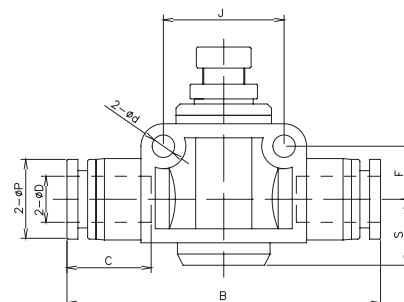

CHECK VALVES

Tube x BSPT

PART NO	A	B	C	E	D1	D2	D3
PCVC04-01	35	15	9	6.2	9.6	4	1/8
PCVC04-02	35	15	9	6.2	9.6	4	1/4
PCVC06-01	35	12.5	10	6.2	13.6	8	1/8
PCVC06-02	35	12.5	10	6.2	13.6	8	1/4
PCVC08-01	35	12.5	12	6.2	13.6	8	1/8
PCVC08-02	35	12.5	12	6.2	13.6	8	1/4
PCVC10-02	40	18	12	6.2	16	10	1/4
PCVC10-03	40	18	12	7	16	10	3/8
PCVC12-02	45	20	12	6.2	19	12	1/4
PCVC12-03	45	20	12	7	19	12	3/8

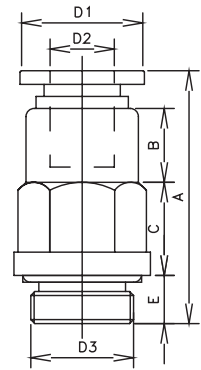

Tube x Tube

PART NO	A	B	C	E	D1	D2
PCVU04	38	35	10	10	9.6	4
PCVU06	41	38	12	10	11.7	6
PCVU08	43	40	14	12	13.6	8
PCVU10	45	40	17	12	16	10

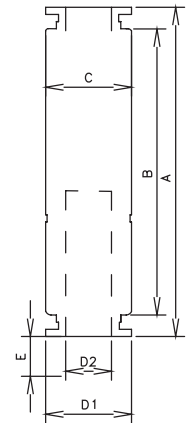

Female x Female, BSPT

PART NO	A	B	C	D1	D2	D3
PCFF01-01	32	12	10	1/8	S14	10
PCFF02-02	38	12	13	1/4	S19	16
PCFF03-03	46	15	16	3/8	22	18
PCFF04-04	46	15	16	1/2	S24	20

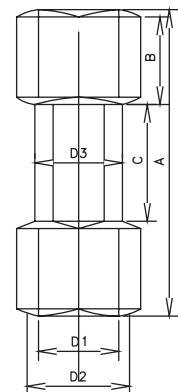

CHECK VALVES

Male x Female, BSPP

PART NO	A	B	C	D1	D2	D3
PCVF01-01	25	19.5	5.5	1/8	1/8	S14
PCVF02-02	26	19	6.6	1/4	1/4	S17
PCVF03-03	32	19	7	3/8	3/8	S19
PCVF04-04	33	19	8	1/2	1/2	S22

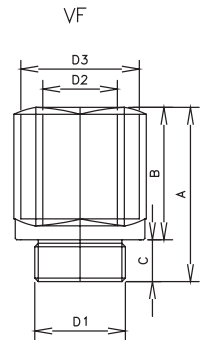

STOP VALVES, SELF SEALING

Tube x BSPT

PART NO	A	B	C	E	D1	D2	D3
SPC06-02	35	15	9	6	11.7	6	1/4
SPC08-02	35	12.5	9	6	13.6	8	1/4
SPC08-03	35	12.5	10	7	13.6	8.4	3/8
SPC10-02	40	18	12	6	16	10	1/4
SPC10-03	40	18	12	7	16	10	3/8
SPC10-04	40	18	12	8	16	10	1/2
SPC12-02	45	20	12	6	19	12	1/4
SPC12-03	45	20	12	7	19	12	3/8

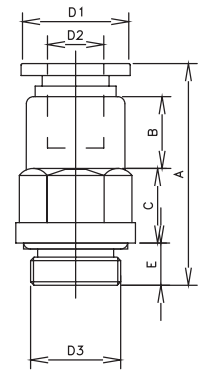

Tube x Tube

PART NO	A	B	C	E	D1	D2	D3
SPU06	41	38	12	20	11.7	6	10
SPU08	43	40	14	21	13.6	8	12
SPU10	45	40	17	22	16	10	12
SPU12	61	50	19	24	19	12	12

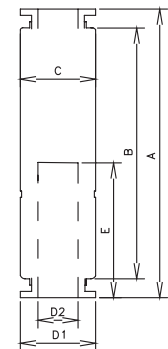

FITTINGS

NPT PLASTIC PUSH-IN

FITTINGS, IMPERIAL

Male Thread (Hex Body), NPT

PART NO	D	D1	R	A	B	C	H
NPT							
2110-7800	1/8	10	NPT1/8	8	21	16	7/16
2110-7826	1/8	10	NPT1/4	11	21.5	16	9/16
2110-7842	5/32	10	NPT1/8	8	21	16	7/16
2110-7859	5/32	10	NPT1/4	11	21.5	16	9/16
2110-7875	3/16	12.8	NPT1/8	8	21	16	7/16
2110-7909	3/16	12.8	NPT1/4	11	21.5	16	9/16
2110-7925	3/16	12.8	NPT3/8	12	24	16	11/16
2110-7941	1/4	12.8	NPT1/8	8	24	17	1/2
2110-7958	1/4	12.8	NPT1/4	11	23.5	17	9/16
2110-7966	1/4	12.8	NPT3/8	12	24.5	17	11/16
2110-7974	5/16	13.8	NPT1/8	8	27	18	9/16
2110-7982	5/16	13.8	NPT1/4	11	26.5	18	9/16
2110-7990	5/16	13.8	NPT3/8	12	25	18	11/16
2110-8006	3/8	16.8	NPT1/8	8	29.1	19.3	11/16
2110-8014	3/8	16.8	NPT1/4	11	31.1	19.3	11/16
2110-8022	3/8	16.8	NPT1/2	15	28.6	19.3	7/8
2110-8063	1/2	20.5	NPT1/4	11	33	20	7/8
2110-8071	1/2	20.5	NPT3/8	12	31	20	7/8
2110-8089	1/2	20.5	NPT1/2	15	29.5	20	7/8

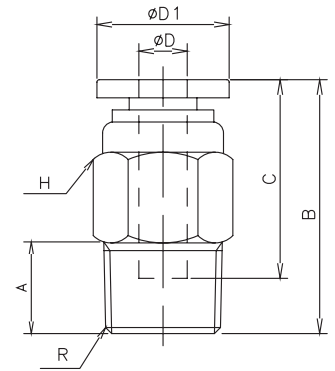

Male Thread (Hex Body), UNF

UNF							
2110-7776	1/8	10	10-32	4	21.5	16	7/16
2110-7834	5/32	10	10-32	4	21.5	16	7/16
2110-7867	3/16	12.8	10-32	4	21.5	16	7/16
2110-7933	1/4	12.8	10-32	4	24	17	1/2

Male Thread (Round), NPT

PART NO	D	D1	R	P	A	B	C
NPT							
2110-8105	1/8	10	NPT1/8	10.5	8	21.5	16
2110-8113	1/8	10	NPT1/4	14	11	22.5	16
2110-8139	5/32	10	NPT1/8	10.5	8	21.5	16
2110-8147	5/32	10	NPT1/4	14	11	22.5	16
2110-8188	3/16	12.8	NPT1/8	12	8	22	16
2110-8204	3/16	12.8	NPT1/4	14	11	24	16
2110-8220	3/16	12.8	NPT3/8	17	12	24	16
2110-8246	1/4	12.8	NPT1/8	12	8	23.5	17
2110-8253	1/4	12.8	NPT1/4	14	11	23	17
2110-8279	1/4	12.8	NPT3/8	17	12	25	17
2110-8311	3/8	16.8	NPT1/8	17	8	28.6	19.3
2110-8329	3/8	16.8	NPT1/4	17	11	31.6	19.3
2110-8337	3/8	16.8	NPT3/8	17	12	29.1	19.3
2110-8345	3/8	16.8	NPT1/2	21	15	30.6	19.3
2110-8352	1/2	20.5	NPT1/4	21	11	34.6	20
2110-8360	1/2	20.5	NPT3/8	21	12	32.1	20
2110-8378	1/2	20.5	NPT1/2	21	15	32.1	20

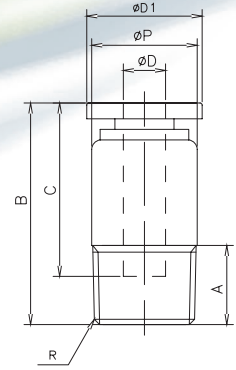

Male Thread (Round), UNF

UNF							
2110-8097	1/8	10	10-32	10.5	4	21.5	16
2110-8121	5/32	10	10-32	10.5	4	21.5	16
2110-8154	3/16	12.8	10-32	10.5	4	22.5	16

Female Thread, NPT

PART NO	D	D1	R	P	A	B	C	H	G
2110-8386	1/8	10	NPT1/8	11	9	26.5	16	1/2	11
2110-8394	1/8	10	NPT1/4	11	12	29	16	11/16	14
2110-8402	5/32	10	NPT1/8	11	9	26.5	16	1/2	11
2110-8410	5/32	10	NPT1/4	11	12	29	16	11/16	14
2110-8428	3/16	12.8	NPT1/8	11.5	9	26.5	16	1/2	11
2110-8436	3/16	12.8	NPT1/4	11.5	12	29	16	11/16	14
2110-8444	1/4	12.8	NPT1/8	13	9	28	17	9/16	11
2110-8451	1/4	12.8	NPT1/4	13	12	31	17	11/16	14
2110-8469	1/4	12.8	NPT3/8	13	13	32	17	7/8	15
2110-8477	5/16	13.8	NPT1/8	15	9	30	18	11/16	11
2110-8485	5/16	13.8	NPT1/4	15	12	32	18	11/16	14
2110-8493	5/16	13.8	NPT3/8	15	13	32.5	18	7/8	15
2110-8501	5/16	13.8	NPT1/2	15	16	37.5	18	1	18
2110-8519	3/8	16.8	NPT1/8	18	9	29.6	19.3	7/8	11
2110-8527	3/8	16.8	NPT1/4	18	12	32.6	19.3	7/8	14
2110-8535	3/8	16.8	NPT3/8	18	13	33.6	19.3	7/8	15
2110-8543	3/8	16.8	NPT1/2	18	16	37.6	19.3	1	18
2110-8550	1/2	20.5	NPT1/4	21	12	34.6	20	7/8	14
2110-8568	1/2	20.5	NPT3/8	21	13	37.1	20	7/8	15
2110-8576	1/2	20.5	NPT1/2	21	16	38.6	20	1	18

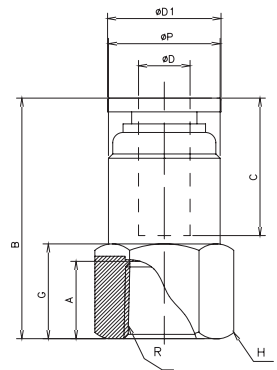

Male Thread, NPT

PART NO	D	D1	R	A	B	C	E	F	H	d
NPT										
2110-8592	1/8	10	NPT1/8	8	25.5	15.5	17.5	8	7/16	3.2
2110-8600	1/8	10	NPT1/4	11	28.5	15.5	17.5	8	9/16	3.2
2110-8626	5/32	10	NPT1/8	8	25.5	15.5	17.5	8	7/16	3.2
2110-8634	5/32	10	NPT1/4	11	28.5	15.5	17.5	8	9/16	3.2
2110-8659	3/16	12.8	NPT1/8	8	28.5	15.6	20.5	9.5	1/2	3.2
2110-8667	3/16	12.8	NPT1/4	11	31	15.6	20.5	9.5	9/16	3.2
2110-8691	3/16	12.8	NPT3/8	12	32.5	15.6	20.5	9.5	11/16	3.2
2110-8717	1/4	12.8	NPT1/8	8	28.5	15.6	20.5	9.5	1/2	3.2
2110-8725	1/4	12.8	NPT1/4	11	31	15.6	20.5	9.5	9/16	3.2
2110-8733	1/4	12.8	NPT3/8	12	32.5	15.6	20.5	9.5	11/16	3.2
2110-8741	5/16	13.8	NPT1/8	8	30	18	22.5	10.2	9/16	3.2
2110-8758	5/16	13.8	NPT1/4	11	33	18	22.5	10.2	9/16	3.2
2110-8766	5/16	13.8	NPT3/8	12	34.5	18	22.5	10.2	11/16	3.2
2110-8774	3/8	16.8	NPT1/8	8	33.7	19.3	26.3	13	11/16	3.2
2110-8782	3/8	16.8	NPT1/4	11	36.7	19.3	26.3	13	11/16	3.2
2110-8790	3/8	16.8	NPT3/8	12	37.7	19.3	26.3	13	11/16	3.2
2110-8808	3/8	16.8	NPT1/2	15	41.7	19.3	26.3	13	7/8	3.2
2110-8816	1/2	20.5	NPT1/4	11	39.2	21.4	28.4	13.6	7/8	3.2
2110-8824	1/2	20.5	NPT3/8	12	40.2	21.4	28.4	13.6	7/8	3.2
2110-8832	1/2	20.5	NPT1/2	15	43.7	21.4	28.4	13.6	7/8	3.2

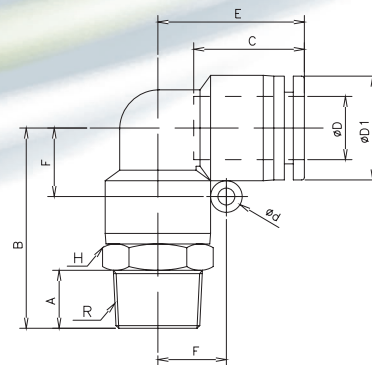

Male Thread, UNF

UNF										
2110-8584	1/8	10	10-32	4	25	15.5	17.5	8	7/16	3.2
2110-8618	5/32	10	10-32	4	25	15.5	17.5	8	7/16	3.2
2110-8642	3/16	12.8	10-32	4	27.5	15.6	20.5	9.5	1/2	3.2
2110-8709	1/4	12.8	10-32	4	27.5	15.6	20.5	9.5	1/2	3.2

Extended Male Thread, NPT

PART NO	D	D1	R	A	B	C	E	F	H	d
NPT										
2110-8557	1/8	10	NPT1/8	8	36	15.5	17.5	8	7/16	3.2
2110-8865	1/8	10	NPT1/4	11	39	15.5	17.5	8	9/16	3.2
2110-8899	5/32	10	NPT1/8	8	36	15.5	17.5	8	7/16	3.2
2110-8907	5/32	10	NPT1/4	11	39	15.5	17.5	8	9/16	3.2
2110-8923	3/16	12.8	NPT1/8	8	41.5	15.6	20.5	9.5	1/2	3.2
2110-8931	3/16	12.8	NPT1/4	11	45.5	15.6	20.5	9.5	9/16	3.2
2110-8943	3/16	12.8	NPT3/8	12	47	15.6	20.5	9.5	11/16	3.2
2110-8964	1/4	12.8	NPT1/8	8	41.5	15.6	20.5	9.5	1/2	3.2
2110-8972	1/4	12.8	NPT1/4	11	45.5	15.6	20.5	9.5	9/16	3.2
2110-8980	1/4	12.8	NPT3/8	12	47	15.6	20.5	9.5	11/16	3.2
2110-8998	5/16	13.8	NPT1/8	8	44.2	18	22.5	10.2	9/16	3.2
2110-9004	5/16	13.8	NPT1/4	11	47.2	18	22.5	10.2	9/16	3.2
2110-9012	5/16	13.8	NPT3/8	12	48.7	18	22.5	10.2	11/16	3.2
2110-9020	3/8	16.8	NPT1/8	8	51.7	19.3	26.3	13	11/16	3.2
2110-9038	3/8	16.8	NPT1/4	11	54.7	19.3	26.3	13	11/16	3.2
2110-9046	3/8	16.8	NPT3/8	12	55.7	19.3	26.3	13	11/16	3.2
2110-9053	3/8	16.8	NPT1/2	15	59.7	19.3	26.3	13	7/8	3.2
2110-9061	1/2	20.5	NPT1/4	11	59.7	21.4	28.4	13.6	7/8	3.2
2110-9079	1/2	20.5	NPT3/8	12	60.7	21.4	28.4	13.6	7/8	3.2
2110-9087	1/2	20.5	NPT1/2	15	64.2	21.4	28.4	13.6	7/8	3.2

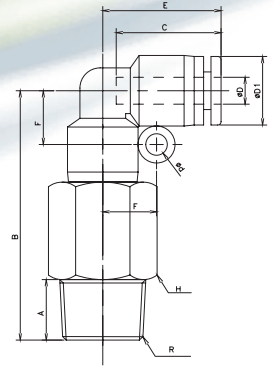

Extended Male Thread, UNF

UNF										
2110-8840	1/8	10	10-32	4	35.5	15.5	17.5	8	7/16	3.2
2110-8881	5/32	10	10-32	4	35.5	15.5	17.5	8	7/16	3.2
2110-8915	3/16	12.8	10-32	4	40.5	15.6	20.5	9.5	1/2	3.2
2110-8956	1/4	12.8	10-32	4	40.5	15.6	20.5	9.5	1/2	3.2

Female Thread, NPT

PART NO	D	D1	R	A	B	C	E	F	H	G
2110-9095	1/8	10	NPT1/8	9	24.5	15.5	17.5	8	1/2	11
2110-9103	1/8	10	NPT1/4	12	25.5	15.5	17.5	8	11/16	14
2110-9111	5/32	10	NPT1/8	9	24.5	15.5	17.5	8	1/2	11
2110-9129	5/32	10	NPT1/4	12	25.5	15.5	17.5	8	11/16	14
2110-9137	3/16	12.8	NPT1/8	9	27	15.6	20.5	9.5	1/2	11
2110-9145	3/16	12.8	NPT1/4	12	30	15.6	20.5	9.5	11/16	14
2110-9178	1/4	12.8	NPT1/8	9	27	15.6	20.5	9.5	1/2	11
2110-9186	1/4	12.8	NPT1/4	12	30	15.6	20.5	9.5	11/16	14
2110-9194	1/4	12.8	NPT3/8	13	31	15.6	20.5	9.5	7/8	15
5110-9202	5/16	13.8	NPT1/8	9	28.7	18	22.5	10.2	9/16	11
2110-9228	5/16	13.8	NPT1/4	12	29.7	18	22.5	10.2	11/16	14
2110-9236	5/16	13.8	NPT3/8	13	32.7	18	22.5	10.2	7/8	15
2110-9251	5/16	13.8	NPT1/2	16	35.7	18	22.5	10.2	1	18
2110-9277	3/8	16.8	NPT1/8	9	32.2	19.3	26.3	13	11/16	11
2110-9269	3/8	16.8	NPT1/4	12	33.2	19.3	26.3	13	11/16	14
2110-9285	3/8	16.8	NPT3/8	13	34.2	19.3	26.3	13	7/8	15
2110-9293	3/8	16.8	NPT1/2	16	39.2	19.3	26.3	13	1	18
2111-0093	1/2	20.5	NPT1/4	12	37.2	21.4	28.4	13.6	7/8	14
2111-0101	1/2	20.5	NPT3/8	13	38.2	21.4	28.4	13.6	7/8	15
2111-0119	1/2	20.5	NPT1/2	16	41.2	21.4	28.4	13.6	1	18

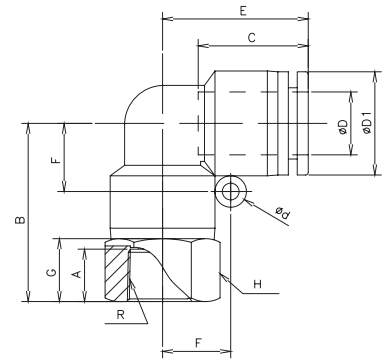

FITTINGS

NPT PLASTIC PUSH-IN

FITTINGS, METRIC

Male Thread, NPT

PART NO	D	R	P	A	B	C	H
2111-2420	4	NPT1/8	9.5	8	21	16	11
2111-2446	4	NPT1/4	9.5	11	21.5	16	14
2111-2461	6	NPT1/8	11.3	8	24	17	12
2111-2479	6	NPT1/4	1.3	11	23.5	17	14
2111-2487	6	NPT3/8	11.3	12	24.5	17	17
2111-2495	8	NPT1/8	13.2	8	26.5	18	14
2111-2503	8	NPT1/4	13.2	11	26	18	14
2111-2511	8	NPT3/8	13.2	12	24.5	18	17
2111-2529	8	NPT1/2	13.2	15	27.5	18	22
2111-2537	10	NPT1/8	15.8	8	30	20	17
2111-2545	10	NPT1/4	15.8	11	32	20	17
2111-2552	10	NPT3/8	15.8	12	28.5	20	17
2111-2560	10	NPT1/2	15.8	15	29.5	20	22
2111-2578	12	NPT1/4	19.6	11	31.5	20	22
2111-2586	12	NPT3/8	19.6	12	29.5	20	22
2111-2594	12	NPT1/2	19.6	15	28	20	22

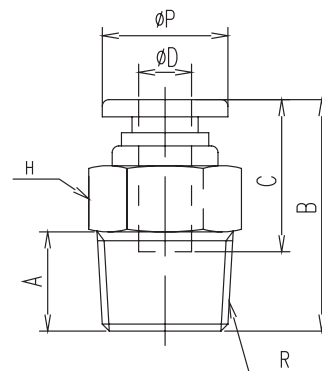

Female Thread, NPT

PART NO	D	R	P	A	B	C	G	H
2111-2602	4	NPT1/8	11	9	26.5	16	11	12
2111-2610	4	NPT1/4	11	12	29	16	14	17
2111-2628	6	NPT1/8	13	9	28	17	11	14
2111-2636	6	NPT1/4	13	12	31	17	14	17
2111-2644	6	NPT3/8	13	13	32	17	15	22
2111-2651	8	NPT1/8	15	9	29.5	18	11	17
2111-2669	8	NPT1/4	15	12	31.5	18	14	17
2111-2677	8	NPT3/8	15	13	32	18	15	22
2111-2685	8	NPT1/2	15	16	37	18	18	25
2111-2693	10	NPT1/8	18	9	30.5	20	11	22
2111-2701	10	NPT1/4	18	12	33.5	20	14	22
2111-2719	10	NPT3/8	18	13	34.5	20	15	22
2111-2727	10	NPT1/2	18	16	38.5	20	18	25
2111-2735	12	NPT1/4	21	12	34.2	21	14	22
2111-2743	12	NPT3/8	21	13	36.7	21	15	22
2111-2750	12	NPT1/2	21	16	43.7	21	18	25

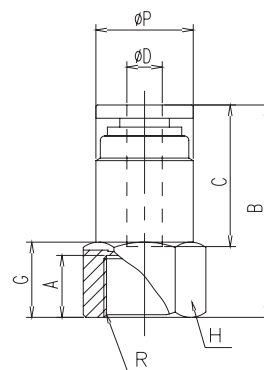

Male Thread, NPT

PART NO	D	R	P	A	B	C	E	H
2111-2768	4	NPT1/8	10.5	8	25.5	15.5	17.5	11
2111-2776	4	NPT1/4	10.5	11	28.5	15.5	17.5	14
2111-2784	6	NPT1/8	13	8	28.5	15.6	20.5	12
2111-2792	6	NPT1/4	13	11	31	15.6	20.5	14
2111-2800	6	NPT3/8	13	12	32.5	15.6	20.5	17
2111-2818	6	NPT1/2	13	15	36	15.6	20.5	22
2111-2826	8	NPT1/8	14.5	8	30	18	22.5	14
2111-2834	8	NPT1/4	14.5	11	33	18	22.5	14
2111-2842	8	NPT3/8	14.5	12	34.5	18	22.5	17
2111-2859	8	NPT1/2	14.5	15	38	18	22.5	22
2111-2867	10	NPT1/8	18	8	33.7	20	27	17
2111-2875	10	NPT1/4	18	11	36.7	20	27	17
2111-2883	10	NPT3/8	18	12	37.7	20	27	17
2111-2891	10	NPT1/2	18	15	41.7	20	27	22
2111-2909	12	NPT1/4	21	11	39.2	21.4	28.4	22
2111-2917	12	NPT3/8	21	12	40.2	21.4	28.4	22
2111-2925	12	NPT1/2	21	15	43.7	21.4	28.4	22

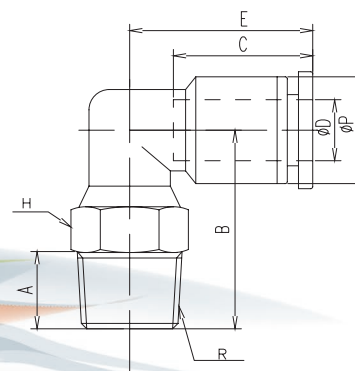

Extended Male Thread, NPT

PART NO	D	R	P	A	B	C	E	H
2111-2933	4	NPT1/8	10.5	8	36	15.5	17.5	11
2111-2941	4	NPT1/4	10.5	11	39	15.5	17.5	14
2111-2958	6	NPT1/8	13	8	41.5	15.6	20.5	14
2111-2966	6	NPT1/4	13	11	45.5	15.6	20.5	14
2111-2974	6	NPT3/8	13	12	47	15.6	20.5	17
2111-2982	8	NPT1/8	14.5	8	44.5	18	22.5	17
2111-3006	8	NPT1/4	14.5	11	47.5	18	22.5	17
2111-3014	8	NPT3/8	14.5	12	49	18	22.5	17
2111-3030	8	NPT1/2	14.5	15	52.5	18	22.5	22
2111-3048	10	NPT1/8	18	8	51.7	20	27	17
2111-3055	10	NPT1/4	18	11	54.7	20	27	17
2111-3063	10	NPT3/8	18	12	55.7	20	27	17
2111-3071	10	NPT1/2	18	15	59.7	20	27	22
2111-3089	12	NPT1/4	21	11	60.7	21.4	28.4	22
2111-3097	12	NPT3/8	21	12	62.2	21.4	28.4	22
2111-3105	12	NPT1/2	21	15	65.2	21.4	28.4	22

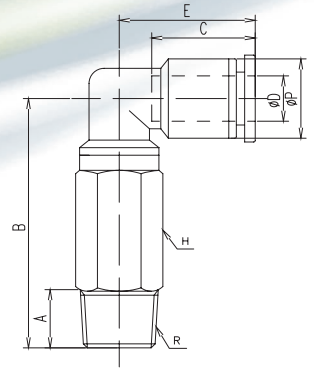

Female Thread, NPT

PART NO	D	R	P	A	B	C	E	G	H
2111-3113	4	NPT1/8	10.5	9	24.5	15.5	17.5	9	11
2111-3121	4	NPT1/4	10.5	12	27.5	15.5	17.5	12	14
2111-3139	6	NPT1/8	13	9	27	15.6	20.5	9	14
2111-3147	6	NPT1/4	13	12	30	15.6	20.5	12	14
2111-3154	6	NPT3/8	13	13	31	15.6	20.5	13	17
2111-3162	8	NPT1/8	14.5	9	28.7	18	22.5	9	17
2111-3170	8	NPT1/4	14.5	12	31.7	18	22.5	12	17
2111-3196	8	NPT3/8	14.5	13	32.7	18	22.5	13	17
2111-3204	8	NPT1/2	14.5	16	35.7	18	22.5	16	22
2111-3212	10	NPT1/8	18	9	32.2	20	27	9	17
2111-3220	10	NPT1/4	18	12	35.2	20	27	12	17
2111-3238	10	NPT3/8	18	13	36.2	20	27	13	17
2111-3246	10	NPT1/2	18	16	39.2	20	27	16	22
2111-3253	12	NPT1/4	21	12	37.2	21.4	28.4	12	22
2111-3261	12	NPT3/8	21	13	37.2	21.4	28.4	13	22
2111-3279	12	NPT1/2	21	16	37.2	21.4	28.4	16	22

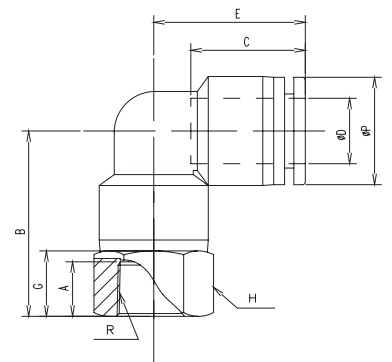

Male Thread, NPT

PART NO	D	R	P	A	B	C	E	F	H	d
2111-3287	4	NPT1/8	10.5	8	25.1	15.5	17.5	8	11	3.2
2111-3295	4	NPT1/4	10.5	11	28.1	15.5	17.5	8	14	3.2
2111-3303	6	NPT1/8	13	8	38.5	15.6	20.5	9.5	12	3.2
2111-3311	6	NPT1/4	13	11	31	15.6	20.5	9.5	14	3.2
2111-3329	6	NPT3/8	13	12	32.5	15.6	20.5	9.5	17	3.2
2111-3337	8	NPT1/8	14.5	8	29.7	18	22.5	10.2	14	3.2
2111-3345	8	NPT1/4	14.5	11	32.7	18	22.5	10.2	14	3.2
2111-3352	8	NPT3/8	14.5	12	34.2	18	22.5	10.2	17	3.2
2111-3360	8	NPT1/2	14.5	15	37.7	18	22.5	10.2	22	3.2
2111-3378	10	NPT1/8	18	8	33.7	20	27	12	17	3.2
2111-3386	10	NPT1/4	18	11	36.7	20	27	12	17	3.2
2111-3394	10	NPT3/8	18	12	37.7	20	27	12	17	3.2
2111-3402	10	NPT1/2	18	15	41.7	20	27	12	22	3.2
2111-3410	12	NPT1/4	21	11	39.2	21.4	28.4	13.6	22	3.2
2111-3428	12	NPT3/8	21	12	40.2	21.4	28.4	13.6	22	3.2
2111-3436	12	NPT1/2	21	15	43.7	21.4	28.4	13.6	22	3.2

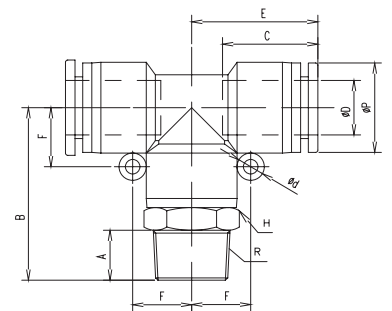

Male Thread, NPT

PART NO	D	R	P	A	B	C	E	F	H	d
2111-3485	4	NPT1/8	10.5	8	25.1	15.5	17.5	8	11	3.2
2111-3519	4	NPT1/4	10.5	11	28.1	15.5	17.5	8	14	3.2
2111-3527	6	NPT1/8	13	8	38.5	15.6	20.5	9.5	12	3.2
2111-3535	6	NPT1/4	13	11	31	15.6	20.5	9.5	14	3.2
2111-3550	6	NPT3/8	13	12	32.5	15.6	20.5	9.5	17	3.2
2111-3568	8	NPT1/8	14.5	8	29.7	18	22.5	10.2	14	3.2
2111-3576	8	NPT1/4	14.5	11	32.7	18	22.5	10.2	14	3.2
2111-3584	8	NPT3/8	14.5	12	34.2	18	22.5	10.2	17	3.2
2111-3592	8	NPT1/2	14.5	15	37.7	18	22.5	10.2	22	3.2
2111-3600	10	NPT1/4	18	11	36.7	20	27	12	17	3.2
2111-3618	10	NPT3/8	18	12	37.7	20	27	12	17	3.2
2111-3626	10	NPT1/2	18	15	41.7	20	27	12	22	3.2
2111-3634	12	NPT1/4	21	11	39.2	21.4	28.4	14	22	3.2
2111-3642	12	NPT3/8	21	12	40.2	21.4	28.4	14	22	3.2
2111-3659	12	NPT1/2	21	15	43.7	21.4	28.4	14	22	3.2

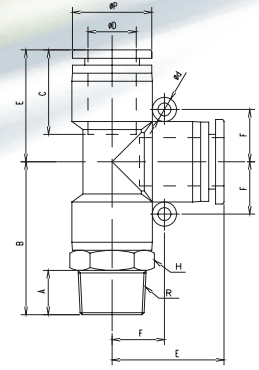

Male Thread, NPT

PART NO	D	R	P	A	B	C	E	F	H	d
2111-3667	4	NPT1/8	10.5	8	42	15.5	10.5	15	11	2.8
2111-3675	6	NPT1/8	13	8	45	15.6	13	15.5	12	2.8
2111-3683	6	NPT1/4	13	11	47.5	15.6	13	15.5	14	2.8
2111-3691	6	NPT3/8	13	12	49	15.6	13	15.5	17	2.8
2111-3709	8	NPT1/8	14.5	8	44.8	18	14.5	15.8	14	3.2
2111-3717	8	NPT1/4	14.5	11	47.8	18	14.5	15.8	14	3.2
2111-3725	8	NPT3/8	14.5	12	49.3	18	14.5	15.8	17	3.2
2111-3733	8	NPT1/2	14.5	15	52.8	18	14.5	15.8	22	3.2
2111-3758	10	NPT1/4	18	11	60.3	20	18	21.3	17	4
2111-3766	10	NPT3/8	18	12	61.3	20	18	21.3	17	4
2111-3774	10	NPT1/2	18	15	63.8	20	18	21.3	22	4
2111-3782	12	NPT1/4	21	11	62.7	21.4	21	21.2	22	4
2111-3790	12	NPT3/8	21	12	63.7	21.4	21	21.2	22	4
2111-3808	12	NPT1/2	21	15	67.2	21.4	21	21.2	22	4

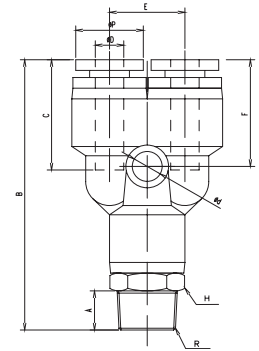

Female Thread, NPT

PART NO	D	R	P	A	B	C	G	H1	H2	M
2111-3816	4	NPT1/8	10	9	27	16	11	14	14	M12X1
2111-3832	4	NPT1/4	10	12	30	16	14	17	14	M12X1
2111-3840	6	NPT1/8	12	9	27.5	17	11	17	17	M14X1
2111-3857	6	NPT1/4	12	12	30.5	17	14	17	17	M14X1
2111-3865	6	NPT3/8	12	13	32.5	17	15	22	17	M14X1
2111-3873	6	NPT1/2	12	16	35	17	18	17	17	M14X1
2111-3881	8	NPT1/8	14	9	28.5	18	11	17	19	M16X1
2111-3899	8	NPT1/4	14	12	31.5	18	14	22	19	M16X1
2111-3907	8	NPT3/8	14	13	35	18	15	22	19	M16X1
2111-3915	8	NPT1/2	14	16	38.4	18	18	25	19	M16X1
2111-3923	10	NPT1/4	17	12	34.5	20	20	22	24	M20X1
2111-3931	10	NPT3/8	17	13	35.5	20	20	22	24	M20X1
2111-3949	10	NPT1/2	17	16	39.5	20	20	25	24	M20X1
2111-3956	12	NPT1/4	20	12	36	21	21	22	26	M22X1
2111-3964	12	NPT3/8	20	13	37	21	21	22	26	M22X1
2111-3972	12	NPT1/2	20	16	39	21	21	25	26	M22X1

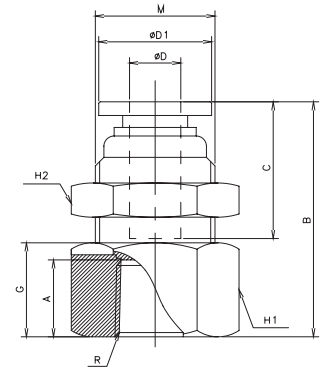

Male Thread, NPT

PART NO	D	R	P	A	B	C	E	H	K
2111-4020	4	NPT1/8	10.5	8	12	15.5	21.8	12	14.5
2111-4038	6	NPT1/8	13	8	12	15.6	23	12	14.5
2111-4053	6	NPT1/4	13	11	12	15.6	25.5	14	18.2
2111-4061	8	NPT1/4	14.5	8	12	18	24.6	12	14.5
2111-4079	8	NPT1/4	14.5	11	12	18	26.8	14	18.2
2111-4087	8	NPT3/8	14.5	12	15.4	18	28.8	11	22
2111-4095	10	NPT3/8	18	12	15.4	20	31.6	22	22
2111-4103	10	NPT1/2	18	15	17.5	20	34.6	25	27.4
2111-4111	12	NPT1/4	21	11	12	21.4	31	22	18.2
2111-4129	12	NPT3/8	21	12	15.4	21.4	33.2	22	22
2111-4137	12	NPT1/2	21	15	17.5	21.4	35.2	22	27.4

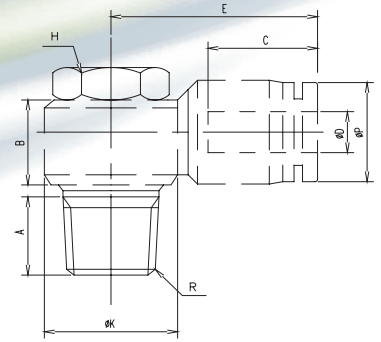

Female Thread, NPT

PART NO	D	R	Rc	A1	A2	B	C	G	H	K
2111-4145	4	NPT1/8	NPT1/8	8	9	31.5	15.5	10.5	12	14.5
2111-4152	4	NPT1/4	NPT1/4	11	12	36.5	15.5	12.8	14	18.2
2111-4160	6	NPT1/8	NPT1/8	8	9	31.5	15.6	10.5	12	14.5
2111-4178	6	NPT1/4	NPT1/4	11	12	36.5	15.6	12.8	14	18.2
2111-4186	6	NPT3/8	NPT3/8	12	13	41.5	15.6	12	22	22
2111-4202	8	NPT1/4	NPT1/4	11	12	36.5	18	12.8	14	18.2
2111-4210	8	NPT3/8	NPT3/8	12	13	41.5	18	12	11	22
2111-4228	8	NPT1/2	NPT1/2	15	16	47.2	18	13.5	25	27.4
2111-4236	10	NPT1/4	NPT1/4	11	12	36.5	20	12.8	14	18.2
2111-4244	10	NPT3/8	NPT3/8	12	13	41.5	20	12	22	22
2111-4251	10	NPT1/2	NPT1/2	15	16	47.2	20	13.5	25	27.4
2111-4269	12	NPT1/4	NPT1/4	11	12	36.5	21.4	12.8	22	18.2
2111-4277	12	NPT3/8	NPT3/8	12	13	41.5	21.4	12	22	22
2111-4285	12	NPT1/2	NPT1/2	15	16	47.2	21.4	13.5	22	27.4

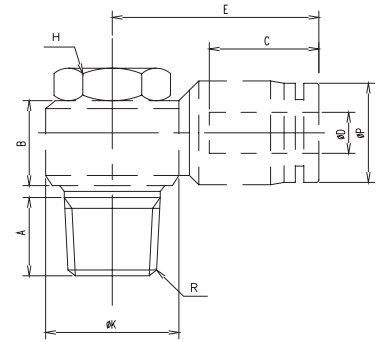

Male Thread, NPT, 3 Outlets

PART NO	D1	D2	R	P1	P2	A	B	C1	C2	F1	F2	H
2111-3980	6	4	NPT1/8	13	10.5	9	67.7	15.6	15.5	8.8	40.4	11
2111-3998	8	4	NPT1/4	14.5	10.5	11	71	18	15.5	8.8	40.4	14
2111-4004	8	6	NPT1/4	14.5	14.5	11	71.4	18	15.6	8.8	40.4	14
2111-4012	10	8	NPT3/8	18	14.5	13	91.3	20	18	10	47	11

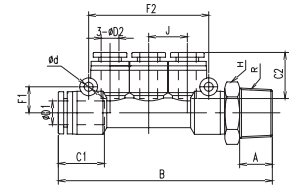

Male Thread, NPT

PART NO	D	R	P	A	C	E	H	K
2111-4293	4	NPT1/8	10.5	8	15.5	21.8	11	14.5
2111-4301	4	NPT1/4	10.5	11	15.5	24	14	18.2
2111-4319	6	NPT1/8	13	8	15.6	23	11	14.5
2111-4327	6	NPT1/4	13	11	15.6	25.5	14	18.2
2111-4335	6	NPT3/8	13	12	15.6	27.1	19	22
2111-4343	8	NPT1/8	14.5	8	18	24.6	11	14.5
2111-4350	8	NPT1/4	14.5	11	18	26.8	14	18.2
2111-4368	8	NPT3/8	14.5	12	18	28.8	19	22
2111-4376	8	NPT1/2	14.5	15	18	30.5	25	27.4
2111-4384	10	NPT1/4	18	11	20	31.6	14	18.2
2111-4392	10	NPT3/8	18	12	20	31.6	19	22
2111-4400	10	NPT1/2	18	15	20	34.6	25	27.4
2111-4418	12	NPT1/4	21.4	11	21.4	31	14	18.2
2111-4426	12	NPT3/8	21.4	12	21.4	33.2	19	22
2111-4434	12	NPT1/2	21.4	15	21.4	35.2	25	27.4

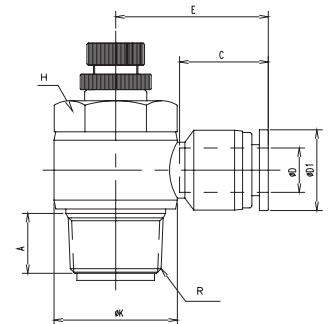

Male Thread, NPT x Tube

PART NO	D	R	P	A	B1	B2	C	E	F	H	K	L	d
2111-4442	6	NPT1/8	14.5	8	40.3	37	15.6	25.5	17	14	16.7	33	4.2
2111-4459	6	NPT1/4	14.5	11	40.3	37	15.6	25.5	17	14	16.7	36	4.2
2111-4467	6	NPT3/8	14.5	13	40.3	37	15.6	25.5	17	17	16.7	36.5	4.2
2111-4475	8	NPT1/8	14.5	8	40.3	37	18	25.8	17	14	16.7	33	4.2
2111-4483	8	NPT1/4	14.5	11	40.3	37	18	25.8	17	14	16.7	36	4.2
2111-4491	8	NPT3/8	14.5	13	40.3	37	18	25.8	17	17	16.7	36.5	4.2

