

SOLENOID VALVES PILOT OPERATED, GENERAL PURPOSE SOLENOID VALVES

Specification

Model	K225-03	K225-04	K225-06	K225-08	K225-12	K225-14	K225-20
Fluid	Air, Water & Oil						
Operation	Pilot						
Type	Normally Open & Normally Closed						
Material of Seal	NBR						
Orifice mm	13	13	25	25	38	38	50
Flow Rate l/pm	55	63	100	160	370	400	540
Port Size	3/8"	1/2"	3/4"	1"	1.1/4"	1.1/2"	2"
Fluid Viscosity	50 CST						
Working Pressure	0.15MPa						
Max Pressure	0.05 to 0.98MPa (7-142psi)						
Temperature	-5 to +80°C						



Symbols

Normally Closed

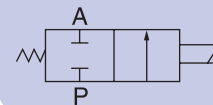

Normally Open

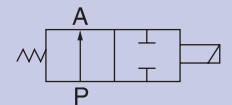

Ordering Code

K 2 2 5	—	0 3	—	230AC	—	NO
Code		Port Size		Voltage		Operation
Two position, two way, brass, pilot operated solenoid		03 : 3/8"		230AC : 230/50V AC		NO : Normally Open
		04 : 1/2"		110AC : 110/50V AC		NC : Normally Closed
		06 : 3/4"		24AC : 24/50V AC		
		08 : 1"		24DC : 24V DC		
		12 : 1.1/4"		12DC : 12V DC		
		14 : 1.1/2"				
		20 : 2"				

Product Features

- 1 2/2 operation.
- 2 Sizes 3/8" to 2" BSPP.
- 3 Available in both Normally Open and Normally Closed functions.
- 4 Valve Timer optional.
- 5 Spare coils available in:
 - 230/50V AC
 - 110/50V AC
 - 24/50V AC
 - 24V DC
 - 12V DC

SOLENOID VALVES PILOT OPERATED, GENERAL PURPOSE SOLENOID VALVES

Flow Charts

K225-03

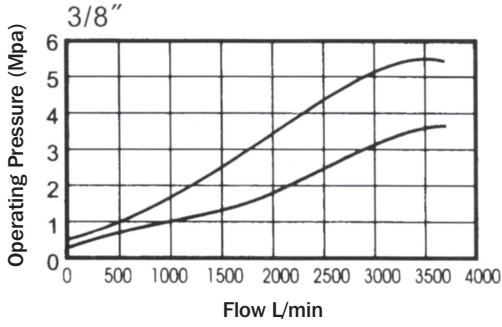

K225-04

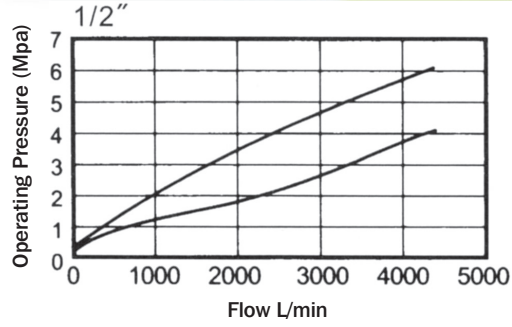

K225-06

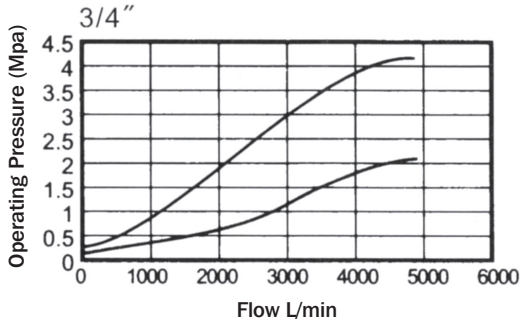

K225-08

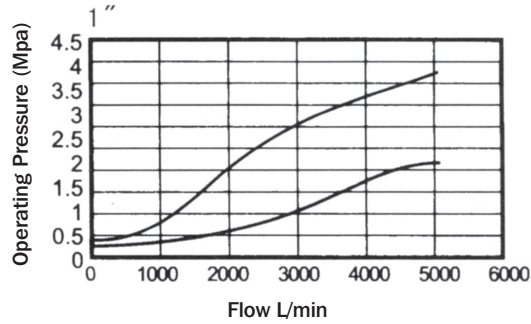

Dimensions

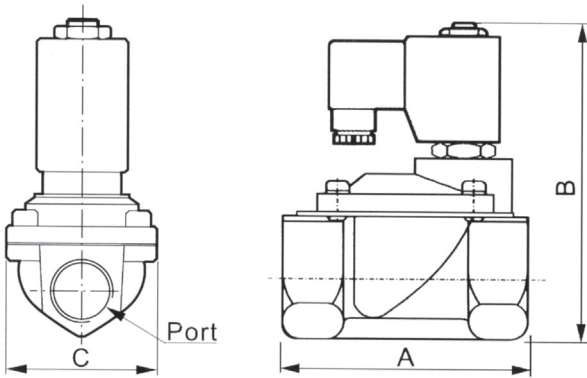

Model	Port	A mm	B mm	C mm
K225-03	3/8"	66.5	106.5	48.0
K225-04	1/2"	66.5	106.5	48.0
K225-06	3/4"	72.0	113.0	58.0
K225-08	1"	96.0	121.0	70.0
K225-12	1.1/4"	128.0	145.5	96.0
K225-14	1.1/2"	128.0	145.5	96.0
K225-20	2"	161.0	160.5	112.0

SOLENOID VALVES VALVE TIMER

FOR USE WITH GENERAL PURPOSE
PILOT OPERATED VALVES K225



Specification / Ordering Code

Model	KVT
Voltage Range	24 to 240V
Protection Class	IP65

Product Features

- 1 Suitable for use with Pilot Operated General Purpose Solenoid Valves K225.
- 2 Also Suitable for DIN 43650B Socket Type Coil.
- 3 Can be used with both Normally Open & Normally Closed.