

CETOP 5: Manifold Block

Features:

- Cast Iron Construction – Phosphated
- 345 Bar Maximum Working Pressure
- 70 L/Min Maximum Flow Rate
- P and T Ports – 3/4" BSP
- A and B Ports – 1/2" BSP

Benefits:

- Reduced Fitting and Installation Costs
- Compact design of valve circuits
- Reduces leak Paths
- Allows for easy modification to valve assembly stacks

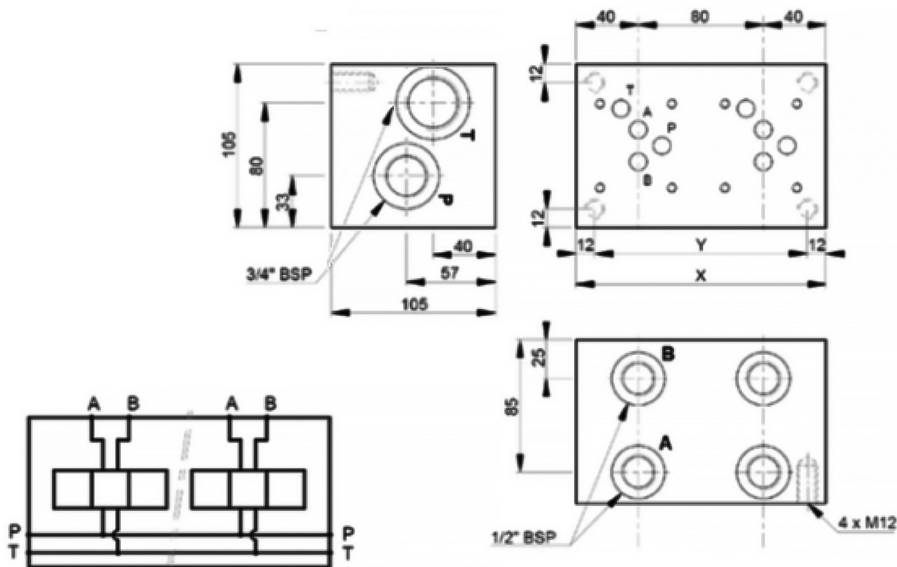

Part Number	No. Stations
CM5-1G	1
CM5-2G	2
CM5-3G	3
CM5-4G	4
CM5-5G	5
CM5-6G	6

CETOP 5: Side Entry Subplate



Features:

- Cast Iron Construction – Phosphated
- 345 Bar Maximum Working Pressure
- 1/2" BSP Ported

Benefits:

- Compact design of valve circuits

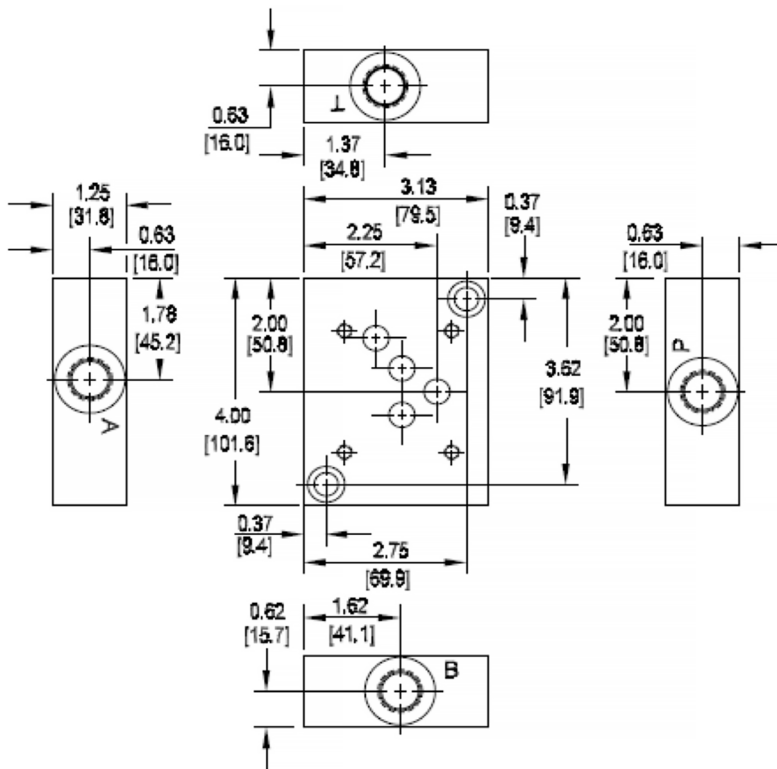

Part Number

CSP-05

CETOP 5: Auxiliary Plates - Blanking Plate



Features:

- Mild Steel Construction – Phosphated
- 345 Bar Maximum Working Pressure
- Supplied with Seals and Screws

Benefits:

- Used to blank off any un-used CETOP 5 interface
- Compact design of valve circuits

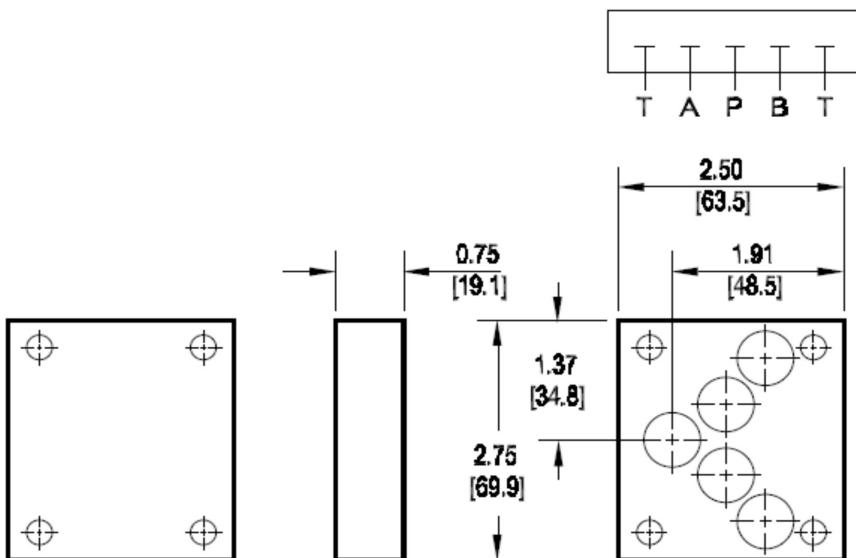
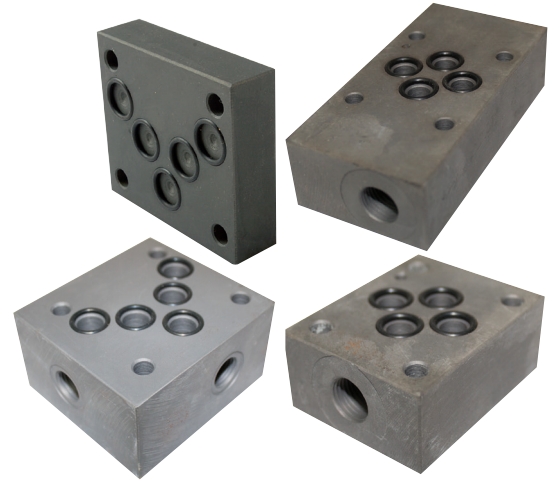

Part Number

CBP-05

CETOP 5: Auxiliary Plates - Cross Over Plates



Features:

- Mild Steel Construction – Phosphated
- 345 Bar Maximum Working Pressure
- Supplied with Seals

Benefits:

- Compact design of valve circuits

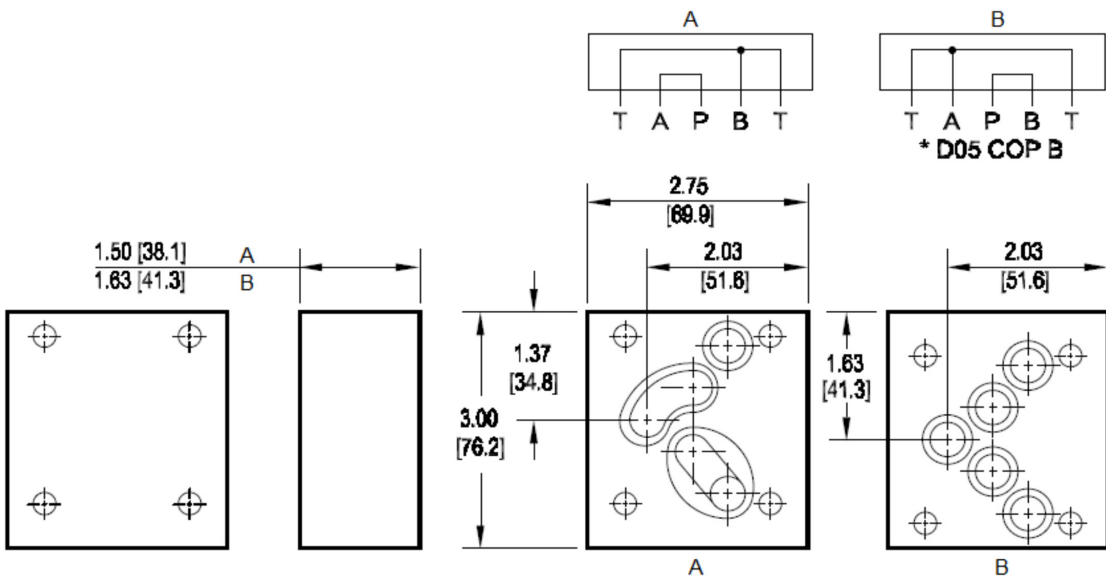
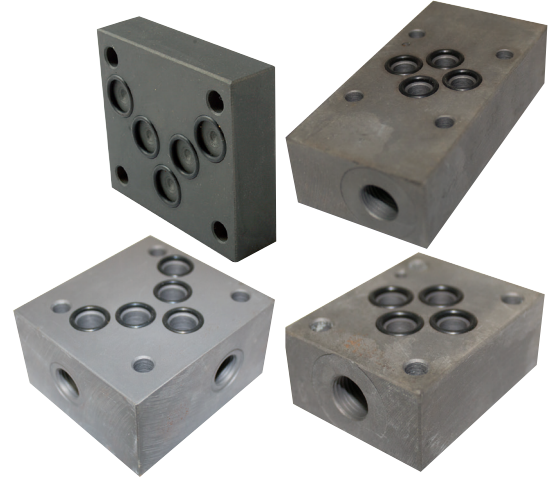

	Part Number	Part Number
A	CCOP-PA-05	Cross Over Plate P - A
B	CCOP-PB-05	Cross Over Plate P - B

CETOP 5: Auxiliary Plates - Tapping Plate A & B



Features:

- Mild Steel Construction – Phosphated
- 345 Bar Maximum Working Pressure
- Supplied with Seals and Screws

Benefits:

- Compact design of valve circuits

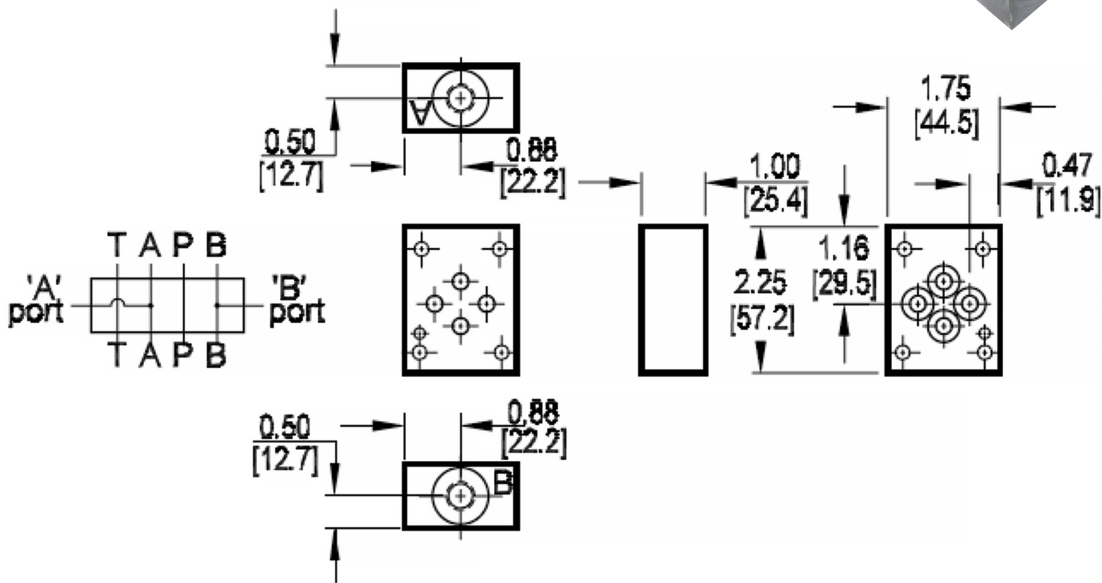
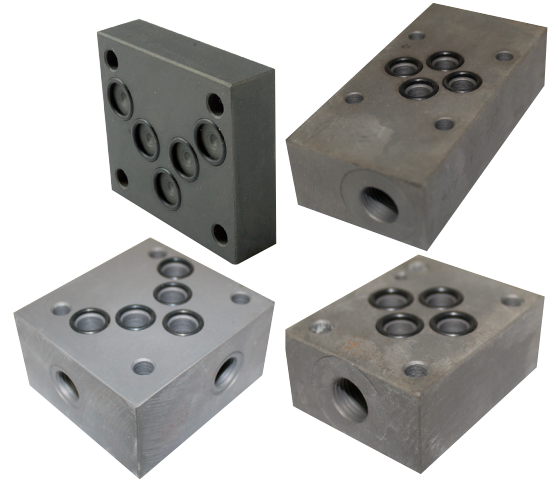

Part Number	Pressure Test Point
CTP-AB-05	A and B Lines

CETOP 5: Auxiliary Plates - Tapping Plate P & T



Features:

- Mild Steel Construction – Phosphated
- 345 Bar Maximum Working Pressure
- Supplied with Seals

Benefits:

- Compact design of valve circuits

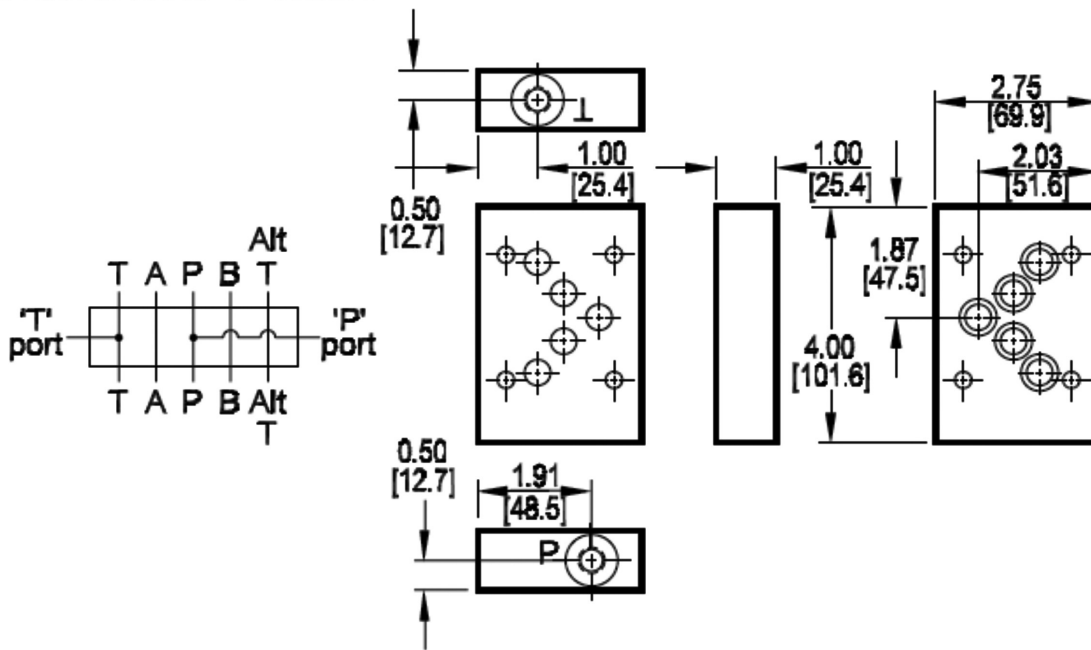

Part Number	Pressure Test Points
CTP-PT-05	P Line